

PURE BOAR BRISTLES

Natural-bristle hair brushes clean the hair better and cause less damage to the hair shafts than the more common synthetic bristled brushes. Our 100% pure boar bristle brush has 80 tufts (set in 7 rows) in an unbreakable acetate handle. Choose from black or white (the bristles are black). Shipping weight 1 lb.



PP-16 Pure Boar Bristle Hair Brush
\$2.95

BOAR/NYLON BRISTLES



This half-and-half blend of boar bristle and nylon combines the brushing and cleaning qualities of natural fibers with the rigidity and scalp stimulation of nylon bristles. Five rows (84 tufts) set in black or white acetate handle. Specify color. Shipping weight 1 lb.

PP-17 Boar/Nylon Bristle Hair Brush
\$2.65

HAND CLIPPERS

Professional-quality, full-size, barber's clippers that will give excellent performance. The high carbon steel cutting blades are machined to permit repeated resharpening. The clippers are operated by an adjustable coil spring. A removable steel tension cap permits easy cleaning. Available in two blade sizes . . . with large teeth (No. 1) for general cutting or very fine teeth (No. 0) for close trimming around the neck area. Shipping weight 1 lb.

PP-18 Hand Clippers No. 1. Ship. wt. 1 lb. \$9.80

PP-19 Hand Clippers No. 0. Ship. wt. 1 lb. \$9.80

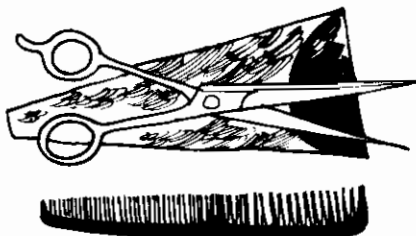
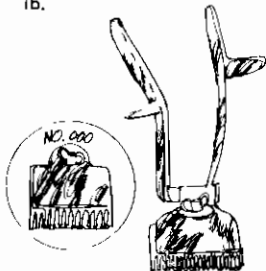

HAIR-CUTTING KIT

Our hair-cutting kit is made up of professional-quality barber tools. Included are 7-1/2-inch cutting shears and 30-tooth thinning shears, both made of high carbon steel, precision-ground and fully polished. The 7-inch tapered barber's comb is hard rubber . . . practically unbreakable. A good-quality, three-piece set at a price sometimes paid for thinning shears alone.

PP-11 Hair-Cutting Kit. Ship. wt. 10 oz. \$12.95

PP-12 Hair-Cutting Shears Only. Ship. wt. 6 oz. \$4.80

PP-13 Thinning Shears Only. Ship. wt. 6 oz. \$8.40

NECK DUSTER

The final touch to any haircut is a deft dusting of the neck with this natural, soft bristle brush made just for the purpose. Ship. wt. 6 oz.

PP-20 Neck Duster \$2.45

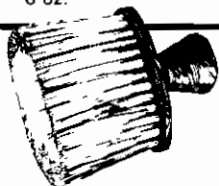

BOOTS



ENGINEER BOOTS

Heavy-duty black oil-tanned leather, specially reinforced one-piece tops and protective leather heel guards. Shanks are reinforced with tempered steel. Sweat-resistant insoles, leather midsoles and Neoprene rubber outsoles. Heel is 1-1/2 inches high. No half sizes larger than 11-1/2.

- C-4666** Engineer Boots. Soft toes. Men's sizes B8-14, C8-14, D7-14, E6-14, EE6-14. **\$39.95**
- C-7863** Engineer Boots. Steel safety toes. Men's sizes C8-13, D6-13, E6-13, EE7-13. **\$42.95**

JET WELLINGTONS

World famous Frye Jet Wellingtons feature the superior comfort of exclusive contour-shaped insteps and the solid support of tempered steel reinforced shanks. The 8-inch tops are of fine calfskin, leather lined and the one-inch heels are durable, comfortable rubber. Fine calfskin vamps are lined with drill, leather soles are weatherized. Men's sizes 6 thru 13, A thru EE.

- F-105** Jet Wellingtons. Black. **\$34.95**
- F-107** Jet Wellingtons. Medium brown. **\$34.95**



HI-TOPPERS

Made of durable cowhide with sporty wide "hunt" straps, a large brass ring and bold rivets. The overall height is 15-1/2 inches including the tapered "dogger" heels (tops are 14 inches). Fully leather lined, weatherized leather soles and blunt square toes. Antiqued-brown color. Men's sizes 7 thru 13, B, D & E.

- F-2225** Frye Hi-Topper Boots **\$49.95**

Made to the same specifications as the above boots except without brass rings and straps and featuring instead straight, stovepipe tops. Men's sizes 7 thru 13, B, D & E.

- F-2175** Frye Hi-Topper Boots. With outside leather pullstraps, as shown. Antiqued-natural color. **\$39.95**
- F-2278** Frye Hi-Topper Boots. Pullstraps are inside, not illustrated. Antiqued-brown color. **\$39.95**

ORDERING INFORMATION

1. All styles are available in whole and half sizes unless indicated otherwise. Half sizes are 1/6 inch. Widths are 1/6 inch.
2. Order men's sizes the same size and width as dress shoes, a width wider for heavy socks and two widths wider for extremely thick socks.
3. Order women's sizes in low heel shoe size and send pencil outline of stockinged feet, made while standing.
4. Boots and shoes are shipped postpaid except foreign orders (see page 3 of catalogue). For special delivery add \$.75.
5. Don't forget to include the following: (1) Catalogue number, (2) color, (3) price and (4) size and width (send the numbers and letters from the linings of a comfortable pair of old shoes if possible).

HIGH-TOP BOOTS

Fifteen inches high with full bellows tongues, these moccasin-type boots lace snugly to fit any leg size. Brown suede leather with cushioned insoles and flexible outsoles.

M-1922 Men's Boots. Whole sizes 7 thru 13. **\$22.95**

M-1422 Women's Boots. Whole sizes 5 thru 10. **\$21.95**

High-Top Boots

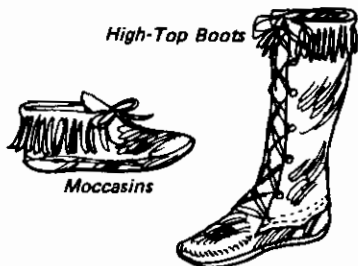

Moccasins

GENUINE MINNETONKA MOCCASINS

So lightweight and comfortable with their cushioned insoles and super-flex outsoles, you'll hardly know you're wearing these soft, brown suede leather moccasins.

M-982 Men's Moccasins. Whole sizes 7 thru 13. **\$12.95**

M-682 Women's Moccasins. Whole sizes 4 thru 10. **\$11.95**

SOLE SAVER



Listed as "gick" in the famous Whole Earth Catalog, this black paste spreads like butter to produce a skid resistant, durable surface on almost anything. Use it to rebuild and prolong the life of shoe soles, bicycle tires and hundreds of other items. Sole Saver is water and fire resistant and will not mark floors. One pint will coat four pairs of shoe soles and make them last ten times longer. Shipping weight 1 lb. 10 oz.

S-1 Sole Saver (one pint) \$4.50

BOOTJACK

Made of hardwood with a leather scuff guard. Shipping weight 2 lb.

FW-1 Bootjack \$2.75

STETSONS

"America grew up under a Stetson," they say, and the name has become a synonym for hat. Practical, serviceable and never out of style, Stetsons are still popular after 109 years on the market.

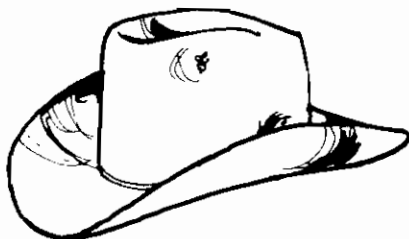

SILVER SHERIFF

Featuring a 6-1/2" Canadian crease, a two-cord band and a 3-1/2" raw-edge brim, this medium-weight, quality Stetson is available in black or bone colors. Sizes from 6-3/8 to 7-3/4. Shipping weight 2 lb.

CG-10 Stetson \$32.00



WINCHESTER

The 6" telescope crown is pre-creased and circled by a braided rawhide band. Offered in chocolate or bullion colors with a 3-1/2" brim. Specify size (6-3/8 to 7-3/4). Shipping weight 2 lb.

CG-11 Stetson \$32.00

SIZE CHART

HEAD SIZE	HAT SIZE
21-5/8 thru 22	6-7/8 to 7
22 thru 22-3/4	7-1/8 to 7-1/4
22-3/4 thru 23-1/2	7-3/8 to 7-1/2
23-1/2 thru 24-1/4	7-5/8 to 7-3/4

CORNCOB PIPES

Most pipe smokers know that for cool, sweet smoking, nothing can match the mellow, rich flavor of a corncob. Our pipes feature generous-sized bowls and biteproof nylon bits. The porous, cool-smoking cob doesn't last long, so most folks buy several of the low-cost pipes at once. Specify curved or straight stems. Shipping weight 2 oz.

The MacArthur Style Pipe has a wooden stem and gold band. Shipping weight 2 oz.

P-1 Corncob Pipe **\$.69**
3 for \$2.00

P-2 MacArthur Pipe **\$1.00**

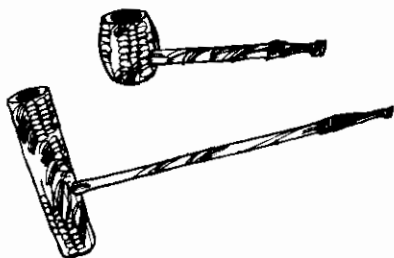

BRASS CUSPIDOR

No self-respecting feedstore owner, tavern operator or railroad stationmaster would have opened his doors for business 100 years ago unless his establishment was properly furnished with one or more cuspidors (spittoons, to the more uncouth among us). These accouterments to genteel chawin'

slowly passed out of favor as the population traded its plug tobacco and snuff for cigarettes . . . and that was all right with most people (especially small boys who were sometimes known to catch a foot in one of the containers). Now, however—whether for good or bad—chewing tobacco and snuff seem to be making a notable comeback. God help us if a resurrection of the ole-time cuspidor does not closely follow this trend!

Well, while we do not necessarily endorse the customs of chewing (tobacco) or dipping (snuff) in any way, we do sympathize with husbands, wives, sons, daughters, cats and dogs who have to live with a practitioner of these habits. For that reason, we've brought back the genuine solid brass (they take a great shine) spittoons that great-granddad found so indispensable. Take your pick from the three most popular sizes of yesteryear . . . and, if you don't need the container for its intended purpose, fill it with fruit or flowers and use it as a "modern antique" conversation piece.

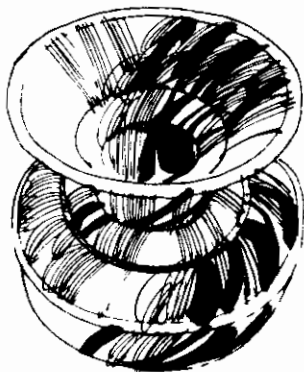

BC-2 Brass Cuspidor. 6-1/2" diameter. Shipping weight 1 lb, 6 oz. **\$8.50**

BC-3 Brass Cuspidor. 8" diameter. Shipping weight 1 lb, 12 oz. **\$11.50**

BC-4 Brass Cuspidor. 10" diameter. Shipping weight 2 lb, 2 oz. **\$17.50**

CHILD CARRIER

Handmade by Heather Fiore, our child carrier is designed for holding an infant (from birth up to about 25 pounds) by strapping the child snugly against the mother's chest (or back for older babies) leaving mother's arms free. Made of sturdy, machine-washable/dryable kettlecloth with padded straps, Heather's child carrier is expected to last as long as you need it. In bright plaid colors, the device comes complete with instructions in finished or kit (all pre-cut materials furnished . . . you just sew it up) form. Shipped postpaid.

CC-10 Child Carrier **\$7.00**

CC-10K Child Carrier Kit **\$5.00**

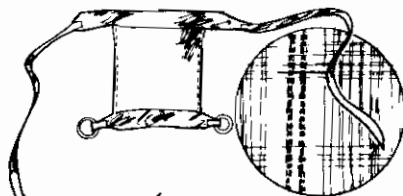

BACK



FRONT

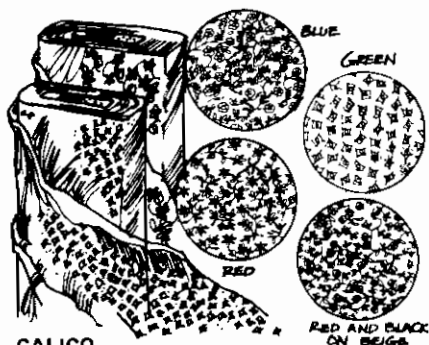

CALICO

You'll find many uses for these 100%-cotton, old-fashioned calico prints. Some of the designs are taken from the original plates used to print the fabrics back in Grandma's day. However our modern, 45"-wide material has a wrinkle-resistant finish which requires much less ironing than Grandma had to do. Since we can't be sure of always having the same colors in stock, please send 35¢ for a swatch card (refundable upon return of the card with your order). If you wish to buy without seeing swatches, please give first, second and third choices of background color. The designs are usually small flowers or geometrics. Sorry, but fabric is not returnable unless in at least 10-yard lengths. Shipping weight 4 oz. per yard.

F-45C 45" Calico

\$2.39 yd.

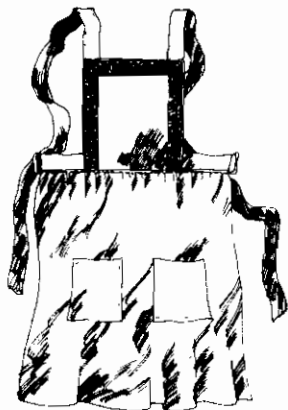

MUSLIN APRON

Here's an apron to wear with your long skirts. Made of unbleached muslin, accented with a colorful bib in your choice of brown with unbleached-white lace border or deep red with multi-color border. It's been described as a working, hostess or cobbler's apron. There are two roomy pockets on the skirt and the length is about 27" from waist to hemline. Specify brown or red bib. Ship. wt. 1 lb. 8 oz.

CG-7 Muslin Apron

\$12.95



BONNET

Made especially for us in Hendersonville, North Carolina using bright prints in various designs. Specify predominant color: red, blue, yellow, green. Ship. wt. 1 lb.

CG-16 Bonnet

\$5.00

CG-16 Child's Bonnet

\$3.50

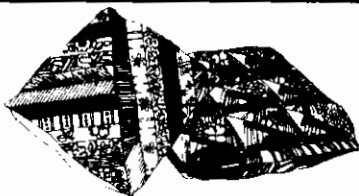

PATCHWORK PILLOW

The ability to create a useful and pleasing product out of scrap is a tribute to American ingenuity. Patchwork, originally a child of necessity, has finally come to be recognized as an important art form and is now enjoying a comeback. Our patchwork pillow has a removable, washable cover consisting of bright prints and complementing solid colors . . . patterns vary. Choose from predominately yellow, red, green or blue. Ship. wt. 1 lb. 8 oz.

PW-1 Patchwork Pillow

\$9.50

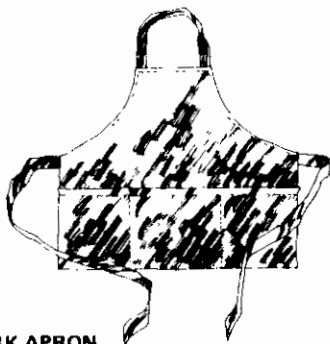

WORK APRON

This sturdy, no-nonsense apron is constructed of strong, heavy navy denim or blue and white ticking . . . it's meant to be useful. The full length—from top of bib to bottom of skirt—is about 28". Three big (11" deep) pockets across the bottom will hold tools, cleaning supplies or whatever. Specify denim or ticking. Ship. wt. 1 lb. 8 oz.

CG-6 Work Apron

\$6.00

BATH PRODUCTS

Our Village Bath Products are scented with pure fresh fruit, vegetable and herb extracts which lend natural nourishment to bath and beauty care preparations. Each of the many fragrances is delightful and real. Beautifully packaged, they make ideal gifts... or give yourself an old-fashioned, natural treat. Most important, Village Bath Products contain nothing harmful to your skin. As the Village people like to say: "It's pure. That's sure."

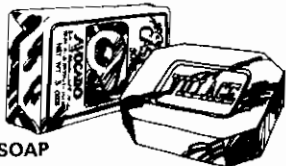

CASTILE SOAP

The beauty secret of pure, mild castile soap is in its olive oil formula. Our castile soaps are made with extravagant amounts of oil combined with pure essences of nature... resulting in a fine, long-lasting product which leaves skin soft and supple. Packaged in boxes of three bars of one fragrance. Choose from Papaya, Avocado, Cornmeal and Rose Hips. Shipping wt. 14 oz.

BP-10 Castile Soap 3 for \$2.00

HAND-ROLLED SOAP BALLS



Milder and less drying than most soaps because the traditional kettle-soap process retains the natural glycerine content, these soap balls produce a thick, creamy lather and leave your skin scented with natural, fresh-fragrance oils. Handcrafted in beautiful, decorative colors in the following assorted scents: honey and almond, orange, bayberry, lemon, lilac, strawberry, rose, lavender, cinnamon, peach, green apple and black cherry. Packaged three in a box. Sorry, no choice of fragrance. Shipping wt. 12 oz.

BP-11 Hand-rolled Soap Balls 3 for \$1.35

PEARS SOAP



This pure soap has been made since 1789 by Messrs. A. & F. Pears, Ltd. of London, England. Absolutely no foreign matter or coloring is added to this cleanser. The clear amber cast of this transparent soap is acquired by aging. Gift packaged in boxes of three 2½-oz. bars. Shipping weight 14 oz.

PS-1 Pears Soap (three bars) \$2.05



EARTH LORE BEAUTY TREATMENTS

Earth Lore is a three-step, natural beauty treatment for the skin: [1] Oatmeal Beauty Scrub deep-cleans the complexion, [2] pure Grapefruit Toner leaves your face feeling tingly and refreshed and [3] Pure Avocado Oil helps to replenish the skin's natural moisture. Try all three or any one you choose. Shipping wt. 14 oz. each.

BP-12 Oatmeal Beauty Scrub \$3.00
 BP-13 Grapefruit Toner \$3.50
 BP-14 Avocado Oil \$4.00
 BP-15 Complete Earth Lore Package, Shipping wt. 2 lb. \$10.00

DIRTY KIDS BUBBLE BATH



Soak your kids clean with our bubbly, completely safe, liquid soap in two delightful fragrances: pink Cinnamon Hots and green Peppermint Twist. Each large (1 qt.) unbreakable plastic jar has its own pumping station. Specify fragrance. Shipping wt. 1 lb. 8 oz.

BP-16 Dirty Kids Bubble Bath \$3.00

CAMEO SOAPDISH



Ceramic soapdish with two soap balls in earthy colors and scents. Shipping wt. 1 lb. 4 oz.

BP-11S \$2.50

SASSAFRAS SOAP



Concocted by a co-op in Wisconsin using an old family recipe, this homemade soap has a fresh sassafras scent, lathers well and is very mild. Comes in 4-ounce bars. Shipping weight 6 oz.

S-2 Sassafras Soap \$1.49
 5 for \$1.95

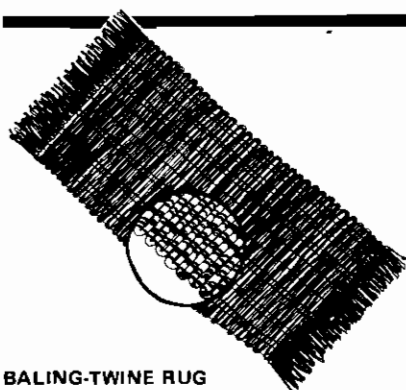

BALING-TWINE RUG

Hand-woven at Happy Acres Studio by Robin Rye, one of the world's more creative people. The rug measures about 25-1/2 X 42 inches plus fringe and is made of strong, serviceable, natural-color baling twine. The first sample we saw was still intact after 20 years of use! Orange and beige, heavy cotton warp threads in alternating groups make an attractive striped pattern, and the ends are finished with hand knotted fringe. Shipping weight 2 lb. 8 oz.

RG-1 Baling-twine Rug

\$9.50

DR. BRONNER'S CASTILE SOAP

Dr. Bronner's liquid castile soap is 100% natural, vegetarian and biodegradable. It's made with coconut, olive and peppermint oils and is pure enough to be used as a mouthwash or toothpaste! Use it to rinse harmful residues from fruits and vegetables . . . or to make a safe insect-repellent spray. You'll find hundreds of uses for this versatile product, a favorite among many health enthusiasts since 1848.

SP-1 Dr. Bronner's (8 oz.). Ship. wt. 12 oz. **\$1.75**

SP-1P Dr. Bronner's (16 oz.). Ship. wt. 1 lb. 4 oz. **\$3.00**



SOAP SAVER

Make use of those leftover bits of soap by collecting them in this metal and screen wire device. Then swish it in your wash water for lots of suds. Can be hung up by the handle. Ship. wt. 8 oz.

S-3 Soap Saver

\$2.75

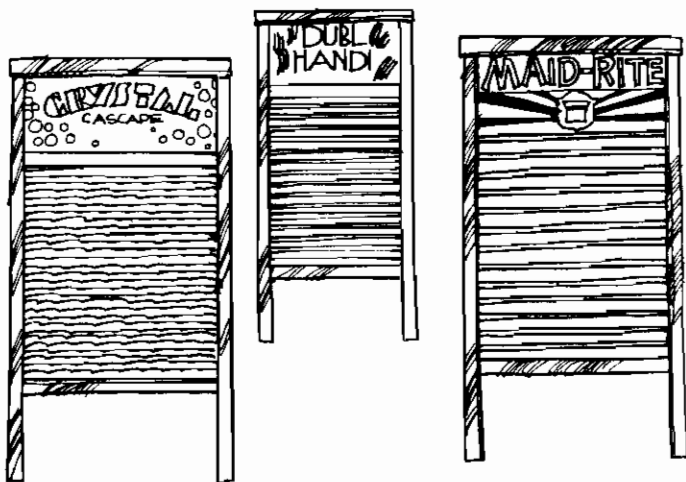

WASHBOARDS

We have three pine-framed scrubbing boards by the Columbus Washboard Company. The Dubl Handi has a 7 by 8-1/2-inch two-sided aluminum washing surface (pick your side according to the material to be cleaned . . . one's coarser than the other). The Maid-Rite has an 11 by 11-inch single-sided aluminum surface. Our best, the Crystal Cascade, has a single-sided glass scrubbing area that measures 11 inches by 12.

HS-8 Dubl Handi Washboard (shipping weight 1 lb. 8 oz.)

\$1.85

HS-9 Maid-Rite Washboard (shipping weight 2 lb. 10 oz.)

\$2.85

HS-10 Crystal Cascade Washboard (shipping weight 4 lb. 8 oz.)

\$3.95

CANDLEHOLDERS

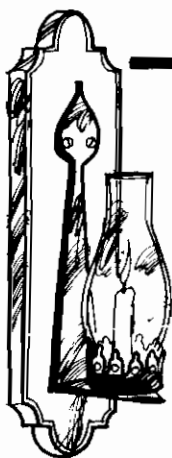

HURRICANE SCONCE

The addition of a crystal globe over a candle keeps the flame from being extinguished in drafty places. Our hurricane sconce is mounted on wood measuring 15" from top to bottom. Shipping weight 2 lb. 2 oz.

IR-8 Hurricane Sconce
\$10.00

PEWTER CANDLESTICK

The warm glow of pewter adds a note of unpretentious grace to any setting. When "poor man's silver" was in common use, perfection was sacrificed for price... now the small flaws appearing in pewter reproduction pieces merely increase their charm. The original from which this solid-pewter, 5"-high candlestick was patterned is now in a museum. Shipping weight 1 lb. 6 oz.

CH-2 Pewter Candlestick

\$9.50



WALNUT CANDLESTICKS & BOWL



Made in Black Mountain, North Carolina and carefully designed and finished to complement the warm, rich hue of genuine walnut. The natural, glossy finish emphasizes the close grain and true color of this beautiful (and increasingly rare) wood. The candlesticks are 8" high and the bowl is 8" in diameter.

CH-3S Walnut Candlesticks & Bowl Set. Ship. wt. 5 lb. **\$34.00**

CH-3 Walnut Candlesticks only. Ship. wt. 2 lb. **\$18.50**

CH-3B Walnut Bowl only. Ship. wt. 3 lb. **\$18.50**

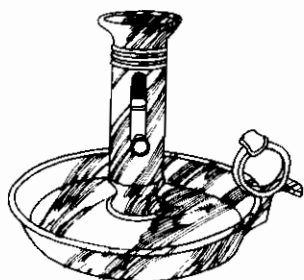

PEWTER CHAMBERSTICK

Pewter or "poor man's silver" was strictly utilitarian in earlier ages and the small flaws and blisters left in finished pieces are now marks of individuality. This reproduction in solid pewter of the popular chamberstick is made in Denmark and shows the same marks as the museum original from which the mold was taken. Beautiful and practical, it's 5 inches in diameter and 5 inches high with a sliding candle raiser. Shipping weight 1 lb. 10 oz.

CH-1 Pewter Chamberstick

\$14.50

COBBLER'S LAMP

A reproduction of a 17th-century cobbler's lamp, this candle lantern has four glass balls which—when filled with clear or colored water—project and intensify light from the candle flame. The darkstained, wood frame measures 7-1/2" X 7-1/2". Four glass balls hang from leather thongs. Shipping weight 2 lb.

CL-9 Cobbler's Lamp

\$10.95

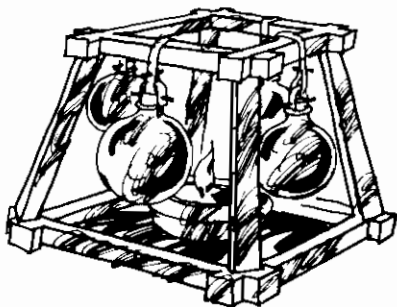

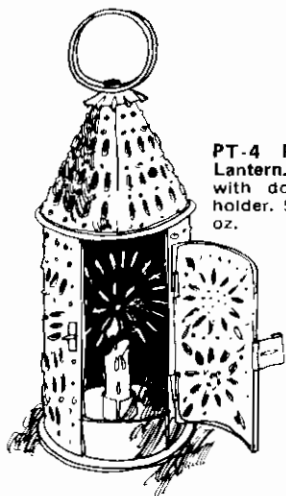

PT-4 Reverse Candle Lantern. 5½ X 15½", with door and candle holder. Ship. wt. 2 lb. 2 oz. **\$18.50**

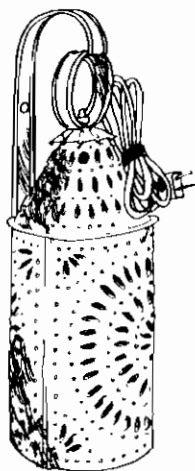

PT-5 Electric Lantern. 5½ X 15½", with hanger and cord. Ship. Wt. 5 lb. 4 oz. **\$21.50**

PIERCED TIN

Authentic reproductions of pierced tin used in early types of lighting, but these new versions are actually sheet steel with a lead coating. The lead gives a mellow glow which darkens gradually to a pewter-like finish and will not rust as the old tin pieces did. Each item is handcrafted by Frank G. Hart of Ohio (with only one assistant) using tools much like those employed by early craftsmen.



PT-3 Bennington Mantle Sconce. 3" diameter x 8½". Shipping weight 1 lb. 2 oz. **\$5.00 each**

PT-1 Pierced Tin Candle Sconce. 3" x 11". Shipping weight 1 lb. 6 oz. **\$8.50 pair**



PT-6 Single Candleholder. 5½" base. Shipping weight 1 lb. 2 oz. **\$1.95**

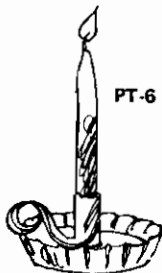

PT-9 Night Light. 8" x 4" triangular shape with a line switch and a five-foot cord. Uses Christmas tree bulb. Shipping weight 1 lb. 6 oz. **\$6.80**

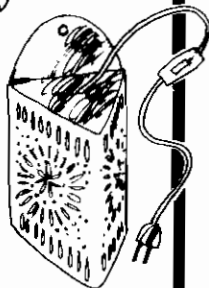

CAST-IRON

MECHANICAL BANKS

Our finest gift and toy item. Each bank is forged at the John Wright Iron Forge in Wrightsville, Pa. Admirable mechanical actions teach the value of saving.

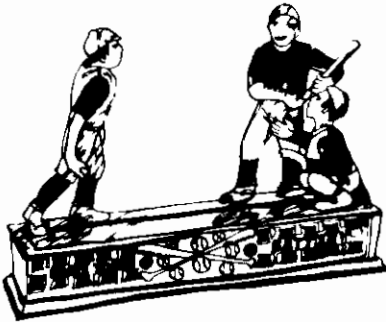

HOMETOWN BATTERY

The pitcher throws the coin, the batter swings and misses and the catcher catches. Action is fast, realistic and funny. Original produced in 1888. Shipping weight 4 lb. 14 oz.

JW-6 Hometown Battery \$27.95



MAGICIAN

A coin is placed on the table in front of the magician. At the push of a switch, he nods, lowers his hat, lifts it up again and the coin has disappeared . . . down an "invisible" chute and into the platform on which the table and magician are standing. Original produced in 1882. Shipping weight 5 lb. 6 oz.

JW-7 Magician \$26.95

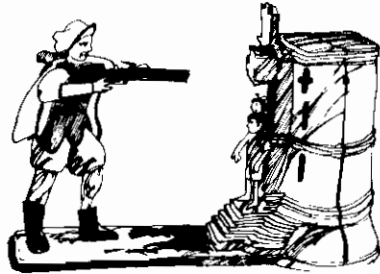

WILLIAM TELL

Father William loads his gun with a coin, shoots the apple from his son's head and rings a bell inside the castle. All action is started by pressing his right foot. Original produced in 1896. Shipping weight 5 lb. 10 oz.

JW-5 William Tell \$29.95



DENTIST

The dentist's fee is placed in his pocket. The tooth is extracted and both go sprawling. The coin drops from dentist's pocket into bank. Original production is 1880. Shipping weight 5 lb. 4 oz.

JW-3 Dentist \$24.95

STILL BANKS



These predecessors of the mechanical banks date back to the 1820's. They are formed in two parts, held together by screws which can be removed to open the banks.

JW-12 Log Cabin Bank. 5-3/4 X 4-1/4 X 3-1/4". Ship. wt. 1 lb. 4 oz. \$7.50

JW-13 Rabbit Bank. 4-1/4 X 4-1/4 X 2". Ship. wt. 1 lb. 2 oz. \$3.50

REPRODUCTIONS

The thoughtfulness with which they designed their tools is evidence of the great pride our forefathers felt in their work. Symbolism, grace and charm appeared in objects that were completely functional. These iron reproductions are cast in sand molds and painted by hand—same as in the good old days—and they're meant to be useful as well as decorative.



HEART TRIVET

Trivets were originally made with three legs so they wouldn't wobble on an uneven hearth. This heart shape is an exact reproduction of a trivet now in a farm museum. Use it as a hearth decoration or to keep hot dishes and coffee pots from burning the table. Shipping weight 1 lb. 6 oz.

IR-1 Heart Trivet

\$3.25

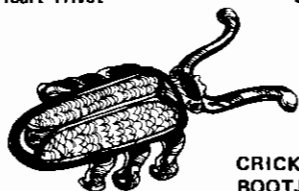

CRICKET BOOTJACK

A cricket on the hearth brings good luck. If it's made of cast iron and designed skillfully enough, the cricket can also be a useful tool for the removal of boots. This one is 9-1/4" long and finished in black. You've probably seen its older cousins in antique shops at three times the price... and our modern cricket is made exactly the same way. Shipping weight 2 lb. 2 oz.

IR-5 Cricket Bootjack

\$3.95



FOOT-SCRAPER

Every farm home needs one of these handy gadgets by the entrance for scraping mud and who knows what-all from boots and shoes. Measuring 5-1/2" across and 3" high, this ornate iron scraper must be bolted down to a solid surface. The finish is black. Shipping weight 1 lb.

IR-3 Foot-Scraper

\$1.85

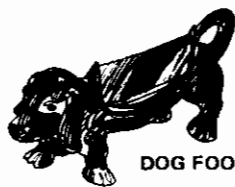

DOG FOOT-SCRAPER

In many older houses and stables, cast-iron dachshunds (with rather sharp spines) still guard doorways against the entrance of dirty boots... and offer their services to remedy the problem. These life-size canines (15-1/2" long) are heavy enough to remain rooted to the spot without being fastened down. Black finish. Shipping weight 14 lb.

IR-4 Dog Foot-Scraper

\$14.95

FOUR-SEASONS PAN



This muffin pan was made with seven cups because seven was believed to be a good number (the Bible said so). The round cup symbolized the summer sun, the scalloped one represented autumn foliage, the star shape was for winter and the heart meant spring. Shipping weight 4 lb. 4 oz.

IR-2 Four Seasons Pan

\$4.20

DOORSTOPS



When houses were sensibly designed to make use of summer's cooling breezes, doorstops were needed to keep their doors from blowing shut. Any small, weighty object would do the job, but we especially like the large (10-1/4" tall) black horse and the life-size (10-1/4" long) reclining cat. The cat is available in black (with green eyes) or white (with green eyes, pink nose and black whiskers).

IR-7 Cat Doorstop. Specify black or white. Shipping weight 6 lb. 4 oz. **\$11.50**

IR-6 Horse Doorstop. Shipping weight 7 lb. 8 oz. **\$14.50**

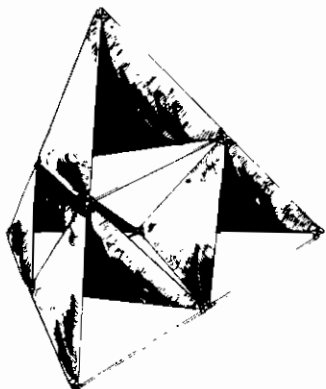

OMNIKITE

Alexander Graham Bell created this tetrahedral cell arrangement which was later made famous by the man-carrying kites of the early 1900's. The modern Omnikite was a recent winner at kite-flying festivals where entries are judged for takeoff and climb, angle and stability. Enthusiasts used to spend days building tetrahedral wonders like this. The Omnikite, however, can be assembled in a matter of minutes. Our kit includes pre-cut wooden struts, special patented hubs and brightly colored plastic sails . . . everything you'll need to put this high flier into the air, in other words, except string. The three-foot tetrahedron can be just as easily disassembled for storage. Beautiful, tough and graceful, it's the kite with the unequalled past. Shipping weight 1 lb.

W-3 Omnikite

\$6.00

STRAWBERRY BARREL

The popularity of strawberry barrels is undeniably deserved. They can produce a great quantity of berries in a very small space . . . and the fruit stays clean. What's more, the barrels are attractive and easy to maintain. Our 7-1/2-gallon-capacity keg is made of basswood with black steel hoops



and has 24 to 30 holes (1-1/8" diameter) already drilled. Ship. wt. 10 lb.

GO-5 Strawberry Barrel

\$12.00

Planting tips:

Cover bottom drainage openings with a layer of gravel, then with soil to the level of the lower holes. Insert plants with their crowns just at the inside of the barrel, spread the roots, cover with soil and moisten. The center of the keg should have a vertical column of gravel for drainage. The crushed stone may be contained in a section of pipe or tile with holes drilled along the sides, or it can be put in place by filling a tin can (which has top and bottom removed) with gravel and slipping the container upward and refilling as the planting progresses. When the barrel is full, plant several strawberries on top. Water and fertilize through the central column of gravel. The keg should be turned regularly so that all plants receive some direct sunlight . . . placing it upon casters or a turntable before filling will make this job easier.

DOME KIT

Tomorrow's building concepts are yours today with the Avionics model dome kit. Basic package takes you through two-frequency dome, add-on kit allows construction of three-frequency model. Consists of wooden struts in two lengths (and colors) and plastic hubs. Shipping weight 1 lb. (each).

W-1 Basic Kit

\$6.50

W-2 Add-On Kit

\$6.50

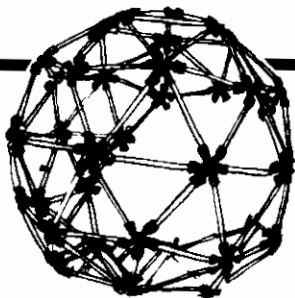

SOKOLARIUM



The Sokolarium is more than just another terrarium. Invented by Alfred Sokolles, this miniature world consists of a sealed glass container inside of which plant life and tiny creatures in the soil carry out their life cycles and are reborn in a completely self-contained regenerative process. The original Sokolarium has survived without watering or ventilation for over 16 years. Now available in a terrarium package consisting of container, plants, special soil, sealant and complete instructions, the Sokolarium will thrive with no attention until it fills the container, dies and—after a few months—begins life all over again. The only requirements are that you carefully follow instructions when planting the terrarium and place it where it will get two hours of sunlight each day and where the temperature rises no higher than 100° F nor falls lower than 50°. We are convinced that the Sokolarium will perform as promised if the instructions are carried out properly . . . therefore our guarantee is limited to the safe arrival of the container and plants. Shipped postpaid from the Sokolarium greenhouses.

Sokolarium S-81. Consists of an 8"-diameter by 14"-tall steeped bowl, a blooming-size African violet and blue and green selaginella. **\$21.95**

Sokolarium S-95. A red-flowering begonia and blue selaginella with a 5"-diameter, 14"-tall, steeped, footed jar. **\$12.95**

Sokolarium S-2251. An 8"-diameter by 16"-tall brandy snifter, African violet, selaginella, fittonia and strawberry geranium. **\$29.95**

SUNDIALS

Sundials can tell time very accurately when properly adjusted for the latitude at which they're used. The pointer (or *gnomon* from a Greek word meaning one who knows or explains) casts a shadow on a calibrated dial to record solar time. Gnomonics (the art of telling time by the sun's shadow) dates back nearly 22 centuries. Because we set our watches by time zones, however, they rarely agree with the time recorded by these "solar-powered clocks". Considered more decorative than useful today, sundials are set for an average latitude to tell approximate time.



The reproduction of an early American sundial is cast in solid bronze with a raised base (9-1/2" diameter) and textured surface. The elegantly simple design has Roman numerals, compass points and the legend, "I count only sunny hours". Shipping weight 3 lb.

SU-1 Colonial Sundial **\$38.50**



The equatorial sundial can be adjusted to any latitude to accurately indicate solar time. Cast in solid bronze with a natural finish which brings out the warm beauty of the metal, its patina (and value) increases with age. 13-1/2" high with a 7-1/4" compass rose base. Shipping weight 5 lb.

SU-3 Equatorial Sundial **\$55.00**

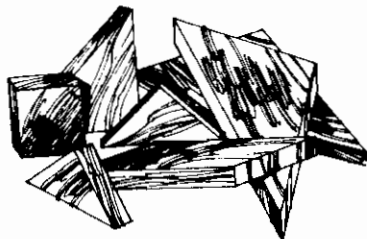

OLD-TIME WOOD PUZZLE

Simply arrange the pieces to make a square. It's surprisingly difficult . . . even after you've done it once or twice. The smooth-finished wooden geometrics are attractive enough to leave on the coffee table to intrigue your guests. No directions, but the puzzle comes assembled . . . and you'd better study the pattern before you take it apart! Ship. wt. 1 lb.

TY-24 Wood Puzzle **\$2.50**

LAMP



BRASS ALADDIN LAMPS

Aladdin's most beautiful lamp is made of high-polished, solid brass. The exclusive mantle/burner permits a bright, steady light adjustable from a "candle glow" to the equivalent of 100 watts of incandescent lighting. A patented burner design produces an efficient blend of 94% air and 6% kerosene for 50 hours of smokeless, odorless operation on one gallon of kerosene. The brass lamp comes complete with a glass shade in a choice of two styles and several colors. *

A-2 Brass Table Lamp with Swirl Shade (Specify Red, Green or White Shade) Shipping weight 7 lb. 14 oz. **\$56.80**

A-12 Brass Table Lamp with Century Shade (Specify Satin Blue or Champagne) Shipping weight 9 lb. **\$63.50**

A-22 Brass Table Lamp with Hand-Painted Century Shade. (Specify violets, dogwood, or rosebuds.) Shipping weight 9 lb.
Violets or Rosebuds **\$66.80**
Dogwood **\$72.00**



A-17 Deluxe Electric Converter (For use with all current-model Aladdin Lamps. Replaces burner. Specify Brass or Nickel finish). Shipping weight 1 lb. 2 oz. **\$11.85**

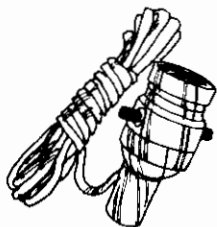

A-16 Standard Electric Converter (For use with all Aladdin Lamps. Installed on burner by removing flame spreader. Nickel finish only). Shipping weight 1 lb. 2 oz. **\$4.60**

A-8 Glass Swirl Shade. Red, Green or White. Shipping weight 4 lb. 12 oz. **\$12.90**



A-13 Glass Century Shade. Light Green, Satin Blue or Champagne. Shipping weight 5 lb. 4 oz. **\$19.60**



A-13P Hand-Painted Shade. White with violets, dogwood blossoms or rosebuds. Shipping weight 5 lb. 4 oz.
Violets **\$23.20**
Rosebuds **\$22.90**
Dogwood **\$28.40**

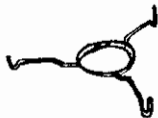

A-14 10" Tripod (Brass or Nickel) for use with glass shades. Shipping weight 6 oz. **\$2.60**

* **NOTE:** Brass lamps are also available with a bright silver-color finish. Specify chrome-plated brass lamp.

DEPARTMENT

ALUMINUM ALADDIN LAMPS

The polished aluminum Aladdins are the workhorses of all kerosene lamps. The burner used on these models is exactly like the one used on the brass lamp, but it is nickel-plated to match the aluminum bowl. A 14-inch parchment shade is available pre-assembled in all-white or unassembled with brown lacing.

A-1 Aluminum Table Lamp (no shade)
Shipping weight 3 lbs. 2 oz. **\$31.30**

A-1M Aluminum Table Lamp with Unassembled Shade. Shipping weight 3 lbs. 10 oz. **\$36.30**

A-1S Aluminum Table Lamp with Assembled Shade. Shipping weight 6 lb. 8 oz. **\$37.20**

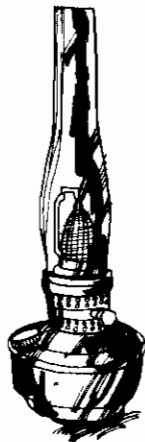
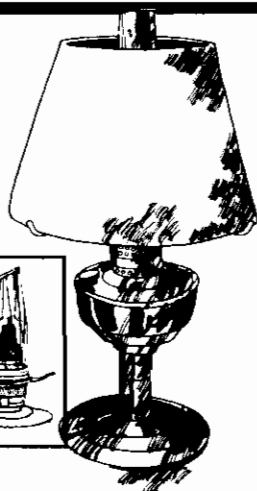

A-9 Shelf Lamp.
Shade not recommended. Shipping wt. 2 lb. 4 oz. **\$27.00**



A-3 Hanging Lamp without shade.
Shipping weight 3 lb. **\$29.95**

A-3S Hanging Lamp with assembled shade. Shipping weight 7 lb. **\$36.00**

A-3M Hanging Lamp with unassembled shade. Shipping weight 3 lb. 8 oz. **\$35.00**



A-11 Wall Bracket for use with Shelf Lamp to make a Wall Lamp. Shipping weight 1 lb. 2 oz. **\$3.75**

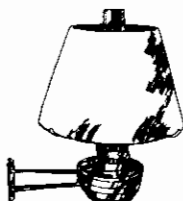

ALADDIN LAMP BOOK

The illustrated story of the development and history of the famous Aladdin burner/incandescent mantle which resulted in the brightest white light ever produced from kerosene. For collectors of Aladdin Lamps and/or old-time advertisements.

Aladdin Book

\$14.95pp

LAMP DEPT.

PARTS & ACCESSORIES

NOTE: Shades, tripods and lamp bases are NOT interchangeable. The brass lamps will accommodate the glass shade with 10-inch tripod and the 14-inch tripod and parchment shade are suitable only for the aluminum lamp.



Chimney



Wick

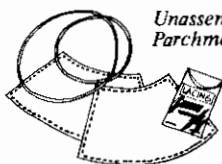

Unassembled
Parchment Shade



Mantle

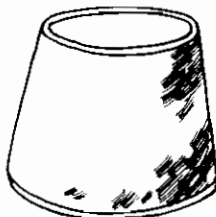

Assembled
Parchment Shade



Hanger

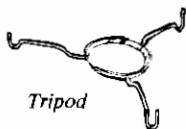

Tripod

A-18	Parchment Shade (assembled) (shipping weight 1 lb. 2 oz.)	\$7.50
A-4	Parchment Shade (unassembled) (shipping weight 1 lb. 8 oz.)	\$5.50
A-15	14-Inch Nickel Tripod (shipping weight 6 oz.)	\$2.60
A-10	Hanger (can be used with Shelf Lamp to make Hanging Lamp). (shipping weight 12 oz.)	\$8.50
A-5	Wick (for all current-model Aladdin Lamps) (shipping weight 6 oz.)	\$1.65
A-6	Mantle (for all current-model Aladdin Lamps) (shipping weight 4 oz.)	\$1.85
A-7	Chimney (for all Aladdin Lamps) (shipping weight 1 lb. 9 oz.)	\$3.80

OTHER ACCESSORIES, INCLUDING SOME REPLACEMENT PARTS FOR OLDER MODELS, AVAILABLE BY SPECIAL ORDER. PLEASE GIVE US THE MODEL NUMBER OF YOUR LAMP (SHOWN ON FACE OF BURNER KNOB) WHEN INQUIRING ABOUT SPECIAL-ORDER PARTS.

KEROSENE LANTERN

Another of those good, old-time quality products you probably haven't seen lately. This all-purpose lantern is of rugged, welded construction with an enamel finish. It has a rising cone burner and clear globe. One filling produces an even white flame which burns for 45 hours. The unit is 13-1/4" tall overall and is exactly the same as the lantern grandpa carried to the barn when he did his chores 50 years ago. Shipping weight 3 lb. 6 oz.

HS-2 Kerosene Lantern	\$8.95
HS-3 Replacement Globe	\$2.35
HS-4 Extra Wick	.45

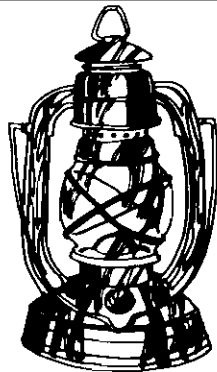

KEROSENE LAMP



The least-expensive kerosene lamp we've been able to put together, this electricity-saver has a 9-inch chimney, stands 18 inches high overall, and holds a little less than a quart of oil. It has a heavy, clear-glass base and a brass Eagle burner. Shipping weight 8 lb. 3 oz. oz.

HS-6 Oil Lamp	\$6.95
HS-7 Extra 5/8-inch Wick	\$.25

CARBIDE LAMPS

HEAVY-DUTY CARBIDE LAMP

Ideal for outdoor and underground use, the carbide lamp gives an intensely brilliant white light by burning acetylene gas generated within the lamp. The acetylene is produced by adding water to chunks of inert carbide through an adjustable valve which controls the size of the flame. The 7"-high, heavy-duty lamp has a 4" reflector and burns 6 to 7 hours on one filling of water and carbide. Shipping weight 1 lb. 4 oz.

CP-10 Heavy-Duty Carbide Lamp	\$14.50
-------------------------------	---------

CARBIDE MINI HAND LAMP

Lighter and more versatile, the 5-1/8"-high mini lamp burns 3 to 4 hours on one filling. 4" reflector, removable carrying handle. Shipping weight 11 oz.

CP-11 Mini Carbide Hand Lamp	\$9.50
CP-12 Carbide Crystals. 2-lb. can	\$3.00

**SOLID FUEL LAMPS REQUIRE ONLY
CARBIDE AND ORDINARY WATER!**



BUCK KNIVES

Blade designs of the Buck Knife are the result of a vast compilation of sketches and descriptions suggested by professional sportsmen. Each knife is designed to fulfill a specific purpose . . . years of research and field testing went into each design. Ship. wt. 12 oz. each.



CP-200 Empress Trio. Consists of one each: 9" carver, 6" utility and 4" paring knife in walnut case. Case may be hung on wall or used in cabinet drawer. **\$60.00**



CP-121 Fisherman. This "fisherman's dream" has a gentle curving 5-1/2" blade for perfect filleting. This is the perfect knife for all kinds of fishing from ultra light to deep sea sport fishing. **\$16.00**



CP-105 Pathfinder. This heavy duty, 5" blade is a wonderful all-purpose knife for general outdoor use. Much heavier blade than CP-118 (Personal). For those who need a rugged knife. **\$18.00**



CP-120 General. Heavy Bowle-styled knife similar in shape to CP-119 (Special) but with 7-1/2" blade. Good for all-around camp use. **\$24.00**



CP-102 Woodsman. A 4" straight blade with a fine point for fish and small game. **\$15.00**



CP-119 Special. A practical Bowle-styled knife with a 6" blade and blood groove. Beautifully balanced and shaped. Designed for heavy all-around knife work. **\$22.00**



CP-103 Skinner. Wide 4" blade, heavy, fine edge. Weight, size and design of this knife makes the toughest skinning jobs simple. **\$20.00**



CP-118 Personal. This famous Buck Knife combines the skinning sweep of the wide skinner with the 4-1/2" slender blade of a small game knife. **\$16.00**

CP-104 Twinset. Combines the CP-102 Woodsman and the CP-103 Skinner. Shipping weight 1 lb. 8 oz. **\$32.50**



CP-133 Buck Honing Kit. Combines Washita Stone, Hard Arkansas Stone and a can of Honing Oil in attractive plastic case. A useful Buck Knife accessory. **\$6.00**



CP-317 Trail Blazer. 4" blade. With Sheath. **\$24.00**

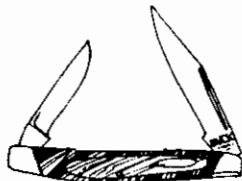

CP-309 Companion. 2-1/8" blade. **\$11.00**

NOTE: All knives, except pocket knives, are equipped with a saddle leather sheath.

THREE BLADES

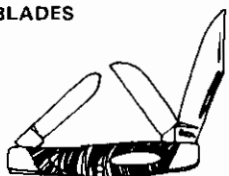

- CP-307 Wrangler, 3-1/4" blade. **\$18.00**
 CP-301 Stockman, 3" blade. **\$15.00**
 CP-303 Cadet, 2-1/2" blade. **\$14.00**

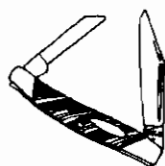

CP-305 Lancer, 2" blade. **\$9.00**

CP-311 Trapper, 3-3/8" blade. **\$13.00**

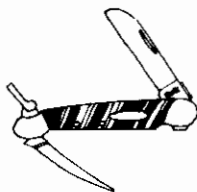

CP-315 Yachtsman, 3" blade. **\$18.00**

CP-313 Muskrat, 3" blade. **\$13.00**

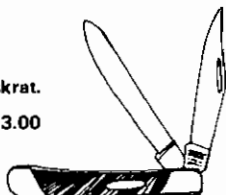

CP-110 Folding Hunter, 4" blade has positive lock in open position. Handle of gold-grain Macassar ebony wood with solid brass bolsters and liner forged in one piece. May be carried in pocket or sheath. An ideal heavy duty outdoor knife for those preferring a folding blade. Over-all length 5". **\$22.00**

CP-112 Rangar. Same design as CP-110 (Folding Hunter) except with 3" blade. Overall length 4-1/4". **\$20.00**

SWISS ARMY KNIVES

The motorist, camper, homesteader and city dweller can all use this "tool box in a knife case". Each blade is precision-made of drop-forged Swedish steel by Switzerland's oldest cutlery manufacturer. Handles are molded on to prevent breakage. Attractive maroon with silver-inlaid casting.

CRAFTSMAN

- Large spear blade
- Small pen blade
- Can opener comb
- Cap lifter comb
- Reamer
- Phillips screwdriver
- File
- Scissors
- Double-cut saw
- Tweezers
- Pick
- Closed 3 1/4"

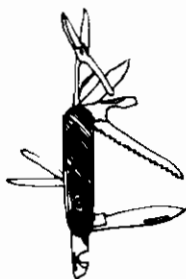

TINKER

- Large spear blade
- Small pen blade
- Can opener comb
- Cap lifter comb
- Reamer
- Phillips screwdriver
- File
- Closed 3 1/4"

- OK-1 Craftsman, Ship. wt. 12 oz. **\$26.75**
 OK-2 Tinker, Ship. wt. 6 oz. **\$13.80**

BARLOW POCKET KNIFE



For Tom Sawyer fans and other admirers of old-time excellence, the bigger and heftier Barlow is the knife to get. This black-handled beauty has two hand-sharpened blades of high-carbon cutlery steel, 1 1/2 inches and 2 1/2 inches long. Shipping weight 6 oz.

- PK-2 Barlow Pocket Knife **\$2.95**

CAMPING

SKACHET



You can cut, slice, chop or whittle with this all-purpose survival tool. With its ultra-sharp cutting notch for opening carcasses, it's especially useful as a skinning knife. A tapered green limb twisted into a special threaded hole converts the Skachet into a light hammer or hatchet. This exceptional piece of outdoor gear is made entirely of high carbon steel and comes complete with a leather safety sheath that easily attaches to your belt. Shipping weight 1 lb. 6 oz.

CP-1 Skachet \$14.95

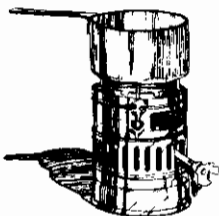

SVEA STOVE

Most really serious mountaineers, backpackers, canoe campers and ice fishermen agree that, for compactness and economy, nothing beats this handy little stove. The Svea requires no pumping or priming and is completely self-contained. It comes equipped with a wind deflector and an aluminum cover that doubles as a small cooking pot. The tiny stove is only 5 inches tall, weighs 20 ounces and will burn for 45 minutes on a third of a pint of white gas. Shipping weight 2 lbs.

AB-1 Svea Camp Stove \$14.85



FIRE STARTER

Explorers, campers, outdoorsmen and anyone who uses an open fire will want our Fire Starter Kit. With it, you can light a fire in any weather without matches. Included are a metal match and strike, special tinder material for easy lighting, waterproof pouch for storage and instructions. Used in U.S. Air Force survival kits, it should be part of yours. Shipping weight 8 oz.

U-1 Fire Starter Kit \$2.65



WATER BAG

Flax canvas has an unusually high tendency to absorb and hold moisture . . . which greatly accelerates the evaporation process by which these top-quality water bags keep their contents cool. Strong, extremely well-made and mildew-proof, the containers have pressed aluminum spouts fitted with corks (which are seized to the bags with waxed sewing thread to prevent loss) and are closed across the top by aluminum slides which can be removed for filling or cleaning. This item available in 1-gallon (12 inches by 12 inches) and 2-gallon (12 inches by 18 inches).

CP-3 Water Bag, 1 gallon (shipping weight 8 oz.) \$2.80

CP-4 Water Bag, 2 gallon (shipping weight 10 oz.) \$3.40

SPACE BLANKET

This ultra-light, multi-purpose outdoor blanket can be used as a wrap, tent or warm weather sleeping bag. It's also ideal as a survival cover and its aluminized surface can (and has) been utilized as a radar reflector allowing stranded hunters, boaters and downed airmen to be easily located by modern search and rescue teams. Constructed of layers of aluminized plastic film on sturdy Nylon fiber, each blanket weighs only 12 ounces. Packs into pocket size and opens to a large 84" x 56". Shipping weight 1 lb. 4 oz.

K-1 Space Blanket \$7.90

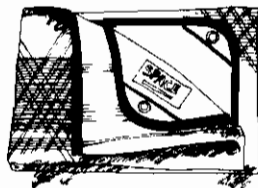



SADDLE BAGS

Constructed of heavy 18-ounce olive drab canvas with 11" by 12-inch pockets and 4-inch boxing. The edges are bound with green braid, and buckled straps of one-inch webbing hold the flaps securely closed. Two 1/2-inch tie grommets are used to fasten the bags to any saddle. Shipping weight 2 lbs.

HE-1 Canvas Saddlebags \$12.95

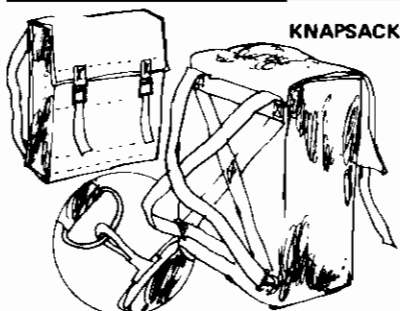

KNAPSACK

Khaki-colored 14.90-ounce duck with olive drab, adjustable shoulder straps. Edges are double-sewn for extra strength. Available in two sizes.

CP-5 Canvas Knapsack (15" x 16" x 6")
Shipping weight 2 lb. 10 oz. **\$11.50**

CP-6 Canvas Knapsack (12" x 15" x 6")
Shipping weight 2 lb. 8 oz. **\$10.50**



BUSH KNIFE

This real heavyweight of bush knives cuts powerfully and easily... hews like a hatchet, saws like a machete and cuts like an axe (trees up to 8 inches in diameter!). It even has a trenching edge, and a no-slip finger grip on the blade to protect your hand while digging. The hand grip is lacquered hardwood, the blade convex-ground 1/8-inch-thick tempered high-carbon manganese steel. Length 16-3/4 inches. Shipping weight 2 lb.

CP-2 Bush Knife with metal carrying sheath \$22.95

CP-2H Bush Knife with zippered canvas case and honing stone. Shipping weight 2 lb. 8 oz. \$27.95

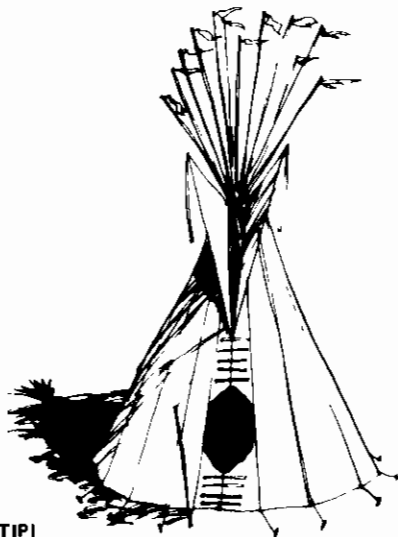

TUPI

The Indian tipi has many advantages over the white man's tent. One of the most important is its natural ventilation; if the cover is rolled up slightly at the bottom, warm air rises through the top opening and cool air is drawn in at ground level. In cold weather, this top opening acts as a very efficient "chimney" allowing the structure to be heated by an open fire in its center. A canvas liner (hung inside the poles) provides insulation.

We offer a Sioux-style tipi, authentic in design, featuring only the best materials and workmanship, and highly recommended by Reginald and Gladys Laubin, authors of *The Indian Tipi*. The fabric is grade A army duck with mildew and rot-resistant waterproofing. The reinforced smoke flaps are adjustable for proper ventilation. An oversize entrance flap offers full weather protection. The overlapping front closure has leather reinforcements and is fastened with wooden lacing pins. All seams are double-sewed, shingle fashion, for maximum strength and watershed. Stakes, anchor rope, all necessary cord and lacing pins are included. Poles are not furnished... saplings or bamboo are generally used.

Specifications

Cat. No.	Diameter	Height	Poles Required	Pole Length
IT-12	12'	11'	14	14 1/2'
IT-16	16'	15'	17	18 1/2'
IT-18	18'	16 1/2'	17	20'
IT-20	20'	18'	20	23'

Prices

Cat. No.	10.10 oz.		12.65 oz.		Liner
	Avalrite	NoBlaze	Avalrite	NoBlaze	
IT-12	\$152.09	\$160.32	\$184.25	\$172.46	\$ 60.94
IT-16	191.16	200.72	232.80	244.44	81.25
IT-18	219.33	229.25	258.21	271.12	91.41
IT-20	277.70	291.59	305.49	320.76	101.56

Poles may be purchased direct from The Bamboo and Rattan Works, Hoboken, N.J.

SLEEPING BAGS

Woods Bag and Canvas Co. Ltd. is one of the oldest and best known sleeping bag manufacturing companies in the world. Their products have been used by such famous explorers as Admiral Richard Byrd and Ronald Amundsen and are still the recognized standard of excellence for use in arctic temperatures. The Woods brand sleeping robe—with its overlap tube construction which completely eliminates cold spots—is the pioneer of the entire down sleeping bag industry. These products are guaranteed against defects in materials and workmanship.



PAC-LITE SLEEPING BAG

Available with varying amounts of select northern goose down fill to conform to the needs of any individual who wants a lightweight backpacker's sleeping bag. The covering and lining are top quality nylon taffeta to insure the maximum breathability at the lightest possible weight. These bags feature the famous Woods overlap tube construction, and snap tabs are sewn in for the addition of optional sheets or flannel liners. A drawstring collar allows the robe to be partially or completely closed at the top, and the full-length, brass zipper separates so that two bags may be joined together to make a double. The finished size is 30" x 80" slightly tapered with five inches additional length in the collar. The acorn-color robe comes with a water-repellent stuff bag.

Catalog Number	Amount of Fill	Temperature Range	Pack Weight	Shipping Weight	Price
SR-11	1¼ lb.	+32° to 75°	about 3¼ lb.	4 lb. 4 oz.	\$64.00
SR-12	1½ lb.	+25° to 70°	about 4 lb.	4 lb. 8 oz.	\$70.00
SR-13	1¾ lb.	+20° to 65°	about 4¼ lb.	4 lb. 12 oz.	\$78.00
SR-14	2½ lb.	0° to 60°	about 5 lb.	5 lb. 8 oz.	\$96.00

SHEET LINER

Washable, sanforized cotton broadcloth, feels like your own bed. Shipping weight 1 lb.

SR-10S Sheet Liner for SR-10 through SR-14. **\$8.80**

COTTON FLANNEL LINER

Soft, washable, cotton flannel plaid. Shipping weight 1 lb.

SR-10C Cotton Flannel Liner for SR-10 through SR-14. **\$8.80**

ALL SEASON SLEEPING ROBE



Effective Temp. Range 50° Below to + 70°

Detachable components make this versatile robe suitable for use at temperatures ranging from 50° below zero to a pleasant 70° above. The entire unit consists of an inner robe and an outer robe, each with a rugged polyester/cotton cover and tightly woven combed Egyptian cotton balloon cloth inside. Covers and linings are treated with DuPont Zepel for water and stain repellency. Snap tabs are sewn in to hold an extra liner . . . available in wool, orlon pile or cotton. Both inner and outer robes are filled with choice waterfowl down in Woods' overlapping-tube construction. The heavy-duty, quick-exit zipper reaches the full length and width of the bags so that each com-

ponent may be opened flat. Two robes will zip together to form a double. The All Season may be used in several ways: (1) Use all components together for sub-zero temperatures. (2) Remove the extra down casing for slightly warmer weather. (3) The outer casing alone is suitable for summer sleeping. (4) There is the additional choice of sleeping between liners at varying levels. Comes complete with dunnage bag.

SR-1 All Season Sleeping Robe (large). Shipping weight 18 lb. **\$189.00**
SR-2 All Season Sleeping Robe (extra large). Shipping weight 20 lb. **\$210.00**

	Large	Extra Large
Total Insulation	4 lbs.	5 lbs.
Inner Robe	1-3/4 lbs.	2-1/8 lbs.
Outer Robe	2-1/4 lbs.	2-7/8 lbs.
Total Approx Wt.	15 lbs.	17-1/2 lbs.
Inner Robe	4-1/2 lbs.	5-1/2 lbs.
Outer Robe	10-1/2 lbs.	12 lbs.
Size Finished (Open)	78 x 84	90 x 90
Size Finished (Closed)	34 x 78	40 x 84

WOOL LINER

Made of finest virgin Wool Kersey with quick-installation snaps which match tabs already in robes. Shipping weight 4 lb. 4 oz.

SR-1W Wool Kersey Liner (78" x 84") for large robe, **\$26.00**
SR-2W Wool Kersey Liner (90" x 90") for extra large robe, **\$28.60**

SHEET LINER

Sanforized cotton broadcloth, will hold up under many washings and feels like your own bed. Shipping weight 1 lb. 8 oz.

SR-1S Sheet Liner (78" x 84") for large robe, **\$8.40**
SR-2S Sheet Liner (90" x 90") for extra large robe, **\$10.10**

COTTON FLANNEL LINER

A snap-in liner in soft, washable, cotton flannel plaid. Shipping weight 1 lb. 8 oz.

SR-1C Cotton Flannel Liner (78" x 84") for large robe, **\$9.90**
SR-2C Cotton Flannel Liner (90" x 90") for extra large robe, **\$10.90**

PILE LINER

Thick, luxurious orlon pile with cotton backing, this snap-in liner is machine washable. Shipping weight 3 lb. 4 oz.

SR-1P Pile Liner (78" x 84") for large robe, **\$26.00**
SR-2P Pile Liner (90" x 90") for extra large robe, **\$28.00**

POP-TENT

Ideal for roadside camping, boat trips, etc., the pop-tent is lightweight, completely portable and—best of all—it can be set up in three minutes. Strong fiberglass ribs lock together to form an outside support . . . no ropes, poles or stakes necessary. The fabric cover is mildew-resistant, water-repellent, 8.16 ounce drill with a sewn-in floor. The door and cross-ventilating window have mosquito netting and storm flaps, and the larger model comes complete with stakes, ropes and poles for making the storm flap into an awning. The small pop-tent is 56 inches high, 81 inches wall to wall, sleeps two and fits into a 30-inch carrying case. The larger model measures 72 inches high, 100 inches wide, sleeps four and packs into a 36-inch case. Both are gray with red trim.

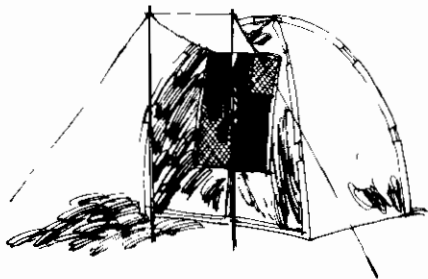

- CP-20 Small Pop-Tent. Shipping weight 16 lb. \$95.00
 CP-21 Large Pop-Tent. Shipping weight 32 lb. \$142.00

OCATE POLYFOAM SLEEPING BAG

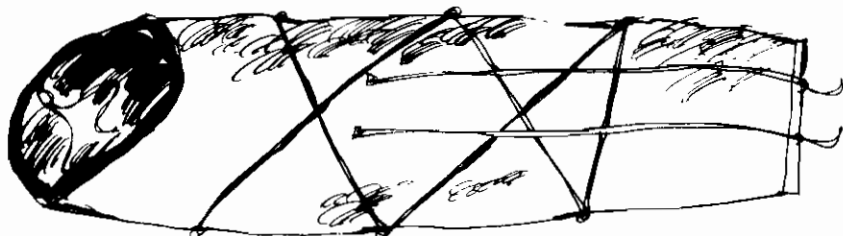

	Length	Weight	Shipping Wt.	Price
SR-20	5'2"	3 lb. 12 oz.	4 lb. 8 oz.	\$50.80
SR-21	5'8"	4 lb.	4 lb. 12 oz.	\$3.60
SR-22	6'2"	4 lb. 4 oz.	5 lb.	\$5.00
SR-23	6'8"	4 lb. 8 oz.	5 lb. 12 oz.	\$9.60

The Ocate Polyfoam Sleeping Bag combines the warmth and lightness of down with the durability and economy of modern synthetics. Made of a special formula polyurethane foam with a ripstop nylon cover and a nylon liner, the bag is comfortable at room temperature down to about zero degrees . . . sub-zero if normal outdoor clothing is worn into the bag. Unlike down or fiberfill, polyfoam provides warmth even when wet. Moisture is warmed by body heat and then expelled through the breathable foam and nylon cover. Polyfoam is lightweight, compresses into a stuff sack of appropriate size for backpacking and its firmness makes an additional sleeping pad unnecessary. The nylon cover is windproof, deflects water and is difficult to tear. Even if the covering is torn, however, the solid foam core stays intact . . . no insulation leaks out. The bag is washable and can be cleaned easily by squeezing it out in a bathtub. We're generally suspicious of plastic but this use of the material seems to work out just fine. Mummy style (no zipper).

BRAZILIAN HAMMOCK

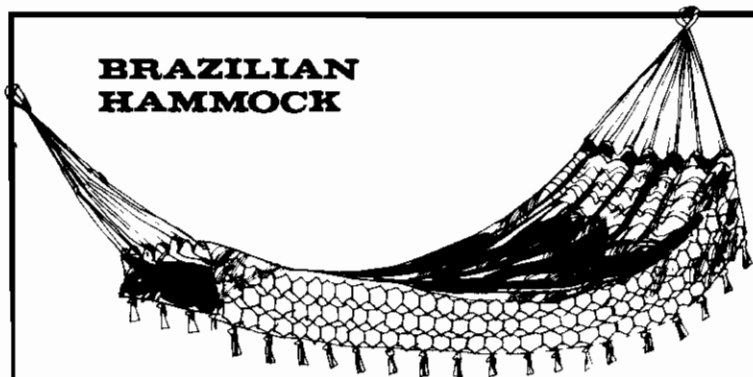

Handwoven Brazilian hammocks will easily support over 1,000 pounds, yet are so soft and comfortable that they are used as beds in their native land. Each hammock is 5' wide and 8' long excluding the support ropes and wide, white fringes. Sturdy, childproof and unconditionally guaranteed, these imported hammocks are available in several colors. Price includes shipping.

H-2 Brazilian Hammock. Specify red, white, orange, blue or green.

\$32.00 pp

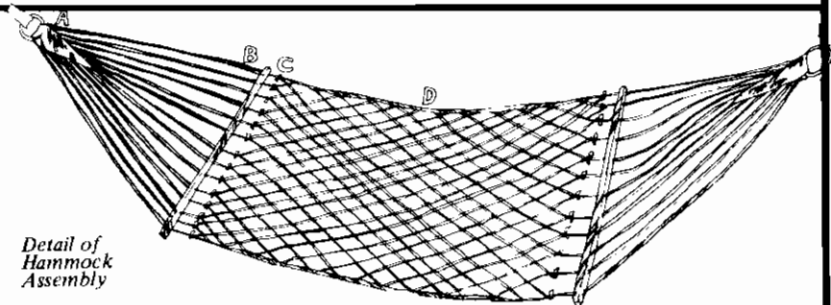

*Detail of
Hammock
Assembly*



TWIN OAKS HAMMOCK

MOTHER'S General Store now handles the famous Twin Oaks handmade hammocks. These fine hanging beds are woven of white, textured, long-life polypropylene rope and are soft and comfortable. They will never rot, mildew, ravel or discolor. Each hammock is kept stable by curved oak stretchers. Hand woven and assembled by the nimble fingers of the residents of Twin Oaks Community. A superior and satisfying product.

H-3 Large (60" x 84" body size, 14' overall length)—big enough for two or three; stretch out crosswise as well as lengthwise. Shipping weight 11 lbs. 14 oz. **\$42.00**

H-4 Medium (54" x 82" body size, 13' overall length)—also large enough for two. Shipping weight 11 lbs. 2 oz. **\$37.00**

H-5 Small (48" x 82" body size, 12' overall length)—large enough to accommodate a single six-footer comfortably. Shipping weight 8 lbs. 12 oz. **\$31.00**



MUSICAL INSTRUMENTS

DULCIMERS

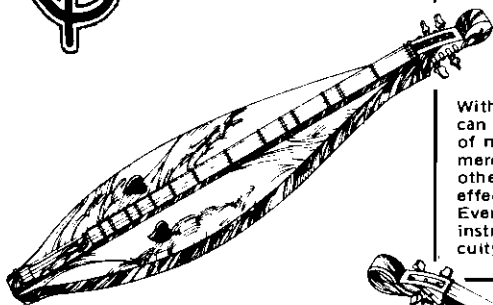

FOUR-STRING DULCIMER

Although the mountain dulcimer traditionally has only three strings, the addition of one string and several frets allows for greater musical variety. This teardrop design is handcrafted by Chet Hines of Ohio and is available in either finished or kit form. Finished instruments are individually hand-constructed of high-quality, close-grained wood, with a great attention to detail and acoustics. Shipping wt. 9 lb. 2 oz.

HM-1 Four-String Dulcimer **\$85.00**

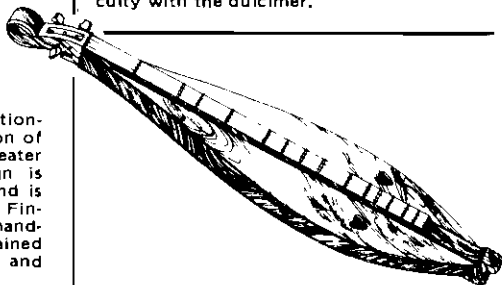

With only a little practice almost anyone can learn to play this traditional instrument of mountain music. The melody of a song is merely picked out on one string and the other two strings "drone" in harmony. The effect is simple and hauntingly beautiful. Even if you've never played a musical instrument before, you'll have little difficulty with the dulcimer.

ROSEWOOD TRADITIONAL DULCIMER

Juan Roberto, an Arizona craftsman, draws from his prized collection of rare Brazilian rosewood to turn out this teardrop-shaped dulcimer. The result is one of the finest 3-string, traditional instruments we've seen anywhere, at any price. Shipping weight 10 lb.

HM-3 Rosewood Dulcimer **\$85.00**

DULCIMER KIT

Same as above, only you get the pre-cut parts, along with complete instructions for assembling and finishing the dulcimer yourself. Shipping wt. 9 lb. 2 oz.

HM-2 Dulcimer Kit **\$56.00**

COPPER FLUTE

The Divine Flute Company down in Micanopy, Florida makes these high-quality flutes...you can't go wrong for the money. It's a nice looking instrument, made of solid copper, and produces a full, beautiful tone in the C and G scales. Comes in plain or fancy etched copper. Fingering chart included with each instrument. Shipping weight 1 lb.

FL-1 Plain Copper **\$15.50**

FL-2 Etched Copper **\$19.50**

FL-3 Leather Carrying Case **\$4.00**

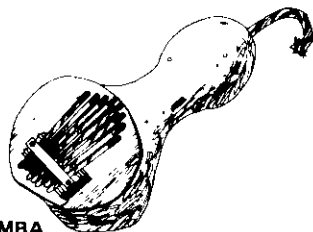

KALIMBA

Pluck the kalimba's metal prongs with the thumbs to produce a pleasing, mellow, marimba-like sound. It's tuned to a pleasant scale and can be returned to any desired pitch with a screwdriver. A popular folk instrument of durable and good quality that has been lovingly crafted from gourds by artisans in Point Arena, California. Ship. wt. 12 oz.

HM-4 Kalimba **\$12.95**

HM-4K Kalimba Kit. Pre-cut parts with complete instructions for finishing. **\$9.50**

AND BOOKS



BAMBOO FLUTE

Mellow-toned bamboo flutes fit easily into backpacks . . . and they're small enough for children's fingers to play. The plain, wrapped (to prevent splitting) bamboo lends itself well to personal decorations. These instruments are in tune but not to a specific key. Ship. wt. 6 oz.

FL-5 Bamboo Fluta

\$5.00

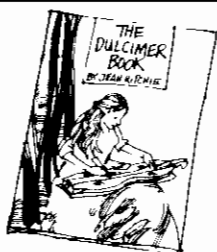

BOOKS

THE DULCIMER BOOK by Jaan Ritchie. A book about the three-stringed Appalachian dulcimer, including some ways of tuning and playing; some recollections in its local history in Perry and Knott Counties, Kentucky; some observations on the probable origins of the instrument in the Old Countries of Europe; with plentiful photographic illustrations and drawings; and with words and music for some sixteen songs. 45 pages. Paperback.

\$2.95 pp



HOW TO MAKE AND PLAY THE DULCIMORE by Chet Hines. First introduced to the dulcimer when he was eight years old, Chet Hines has since handcrafted more than 750 of the instruments. His book includes the origins of the dulcimer and a beginner's guide to playing it as well as complete instructions (with full-size pattern sheets) for building your own copy of the instrument which Hines considers his masterpiece. 157 pages. Hard cover.

\$9.95pp

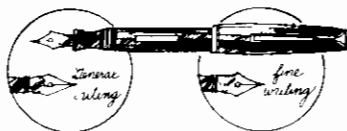

FOUNTAIN PEN

Why use throwaway, ball point pens when you could be writing with a long-lasting, lever-fill fountain pen. This instrument has a tough plastic barrel, chrome trim and replaceable, interchangeable writing points. Choose a fine or general writing nib . . . or—better yet—get both. Barrel colors are red, blue or black. Uses any standard fountain pen ink. Shipping weight 2 oz.

FP-1 Fountain Pen

\$2.98



SHOPPING BAG

Help stop the waste of countless paper containers by carrying this heavy-duty, canvas bag wherever you shop. It measures a big 16" wide by 18" deep and is made of thick, natural-color fabric with matching web straps. "MOTHER'S Tree Saver" is printed in green. Shipping weight 10 oz.

\$4.95

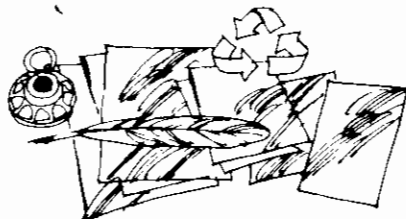

FINE QUALITY RECYCLED PAPER

Now available for the first time . . . a quality writing or typing paper made of 100% recycled fibers. Ideal for any purpose. Please specify your choice of gold, green, clay, blue-gray.

R-1	100 8½ x 11 sheets	\$1.80 pp
R-2	200 8½ x 5½ sheets	\$2.25 pp

CRAFTS

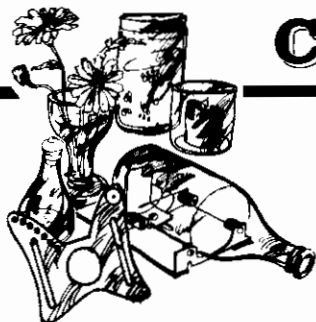

BOTTLE CUTTER KIT

Ephrem's Olde Time Bottle Cutter kit comes complete with everything you need to turn discarded bottles into useful and decorative glassware. Horizontal design allows you to cut almost any round bottle, regardless of neck size. Kit includes cutter tool, candle, polishing paper and powder and full instructions with suggested projects. Shipping weight 1 lb. 6 oz.

B-1 Bottle Cutter Kit \$10.00

BOTTLE BOSS

The latest advance in the art of bottle cutting allows you to cut a bottle almost anywhere you wish. Bottle Boss can be attached to Ephrem's Bottle Cutter to give you more versatility, or you can use it as a hand cutter and make free-form designs, scallops, even holes. Shipping weight 6 oz.

B-2 Bottle Boss \$4.50

TABLETOP LOOM

A primitive, continuous warp, tabletop loom handcrafted by Neal Patterson of Nebraska. The weave is 18" wide and loom will handle lengths of 4, 7 or 10 feet. Designed for relatively coarse work and should not be used for finely textured weaving. Ideal for the beginner or experienced weaver who wants a simple loom for smaller projects. Instructions and shuttle included. Shipping weight 8 lb. 12 oz.

WV-1 Loom \$32.95

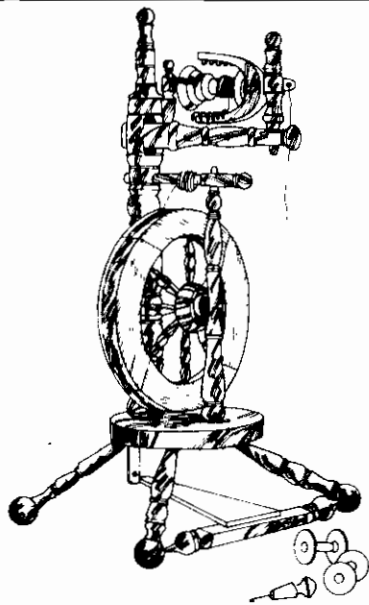
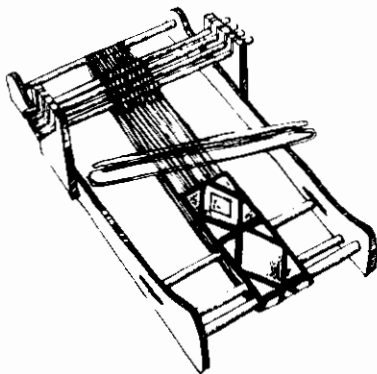

SPINNING WHEEL

For the dedicated craftsmen who take particular delight in the tools of their trade, our finely fashioned spinning wheel will be a joy indeed. It is made of cherry wood (noted for its beautiful color and dimensional stability) with a few components of durable maple. The seventeen individual lathe turnings and joining of parts is done by hand. All hardware is brass, and the wheel is finished with Danish oil. The tension device is so designed as to move the entire spindle/flyer/maiden assembly which remains parallel to the floor when changing tension on the drive band. The orifice is 5/16" in diameter and will spin or ply any normal-size thread and any fiber. Two different-diameter grooves are featured on the whorl: the larger is used for ordinary spinning and the smaller gives more twist for making warp thread or for special effects. Three bobbins come with each wheel and more may be ordered... each hold about 2-1/2 ounces of spun wool. This beautiful and functional tool measures 32" tall and is of traditional European design. Shipped via U.P.S. in a special carton, it needs only minimal assembly... no tools required. Please include \$6.00 for packing and shipping.

SW-1 Spinning Wheel \$120.00



BACKSTRAP LOOM

Backstrap weaving is easy, fast and rewarding. Within an hour of taking your loom out of the box, you can be making scarfs, wall hangings, table runners, place mats, belts, handbags or similar items. A great variety of yarns can be woven into strips up to 17" wide . . . sew them together if more width is desired. The loom includes a 17" heddle, three beams, one shuttle, one backstrap and an instruction booklet. Ship. wt. 2 lb. 8 oz.

WV-3 Backstrap Loom \$11.95

BOOKS

NEW KEY TO WEAVING by Mary Black. More than you need to know about looms and weaving in exhaustive text, tables and 640 illustrations. **REALLY** tells you how. 573 pages, Hard cover, **\$13.95**

YOUR HANDSPINNING by Elsie Davenport. The mother of a friend of mine once knitted a pair of socks from hair shed by the family dog. This could be where she learned how. 130 pages, Paperback. **\$4.25**

BOOKS

CRAFTSMEN OF NECESSITY by Christopher Williams. An "Indigenous builder" is a craftsman who uses nature's materials to build a home, vehicle, household tool or farm implement without vandalizing the environment or wasting precious resources. **CRAFTSMEN** is both a handbook and a celebration about such artisans . . . Calabrians who mold a boat from a tree's natural curves, Rumanians who carve each shingle of their church, Bedouins who smooth dirt and vegetation into rounded shelters and many others. The author contrasts this type of harmonious association between man and nature with the wasteful excesses of modern technology to demonstrate that, if we are to ever recapture the aesthetic view of life, we must all learn to be indigenous builders . . . to work *with* and not *against* our environment. 182 pages.

Paperback **\$3.95**, Hard cover **\$10.00**

BATIK by Robin and Jennifer Shaw. Batik has been popular with both artists and craftsmen since its Eastern origin about 2,000 years ago. Although a demanding skill to master, it has such vast creative possibilities that it continues to be both worthwhile and exciting to beginners and veterans alike. **BATIK** limits itself to a thorough examination of those techniques that enable an artisan to transfer creative ideas onto cloth and work skillfully with the tjanting or brush. Tools and materials, color harmonies, original design and display ideas are rounded out with ten specific projects. Diagrams and photographs illustrate the text. 96 pages. Paperback. **\$3.95**

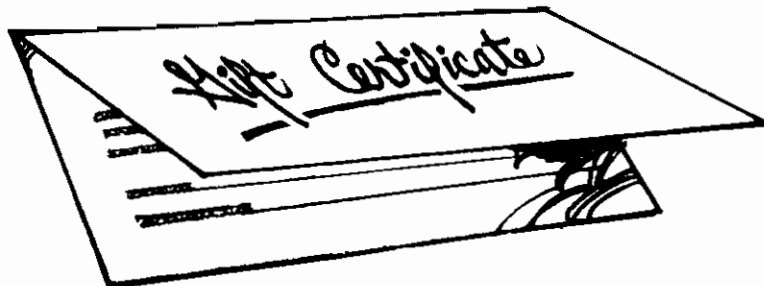

MOTHER'S GENERAL STORE GIFT CERTIFICATES

One of the most thoughtful of all ways to tell a friend or relative that you care. Send us a check or money order for any amount (\$5.00 or more) and the name and address of the person to whom you'd like a gift certificate sent. We'll do the rest.

A new MOTHER'S General Store catalogue and attractive gift certificate (naming you as the donor) will be sent to the individual

you've designated. The recipient may then browse through the accompanying catalogue to his or her heart's content and use the certificate as full or partial payment for any merchandise available from MOTHER'S General Store.

Folks who've tried the idea (both as donors and recipients) think it's great! Give it a whirl. We're sure you'll like it too!

LEATHERWORKING TOOLS

BRENDAN'S LEATHER BOOK by Brendan Smith. Warm, friendly instructions guide the beginning leatherworker through choosing tools and leather, setting up a workshop, stitching, dyeing and finishing. This book will be extremely helpful to those who wish to work with heavy, bark-tanned hides to make belts, purses and sandals from Brendan's many beautiful and practical designs. 168-page, large paperback.

\$3.50 pp



LS-1 Leather Punch: Made in West Germany of pressed steel with a revolving head and six drive tubes for punching different-size round holes (sizes 1-5 plus 7). Shipping weight 1 lb.

\$3.90



RIVETING MACHINE

For setting tubular or clinch rivets. 6-1/2 inches high. Shipping weight 2 lb. 10 oz.

RM-1 Riveting Machine \$10.50

COPPERED TUBULAR RIVETS

50 per box, assorted sizes from 4/16-inch through 8/16-inch. Shipping weight 10 oz.

RM-1T Coppered Tubular Rivets \$.89



DESIGNING WITH LEATHER AND FUR (Real and Fake) by Mary Patton. Learn how to select and care for tools, design and cut patterns, decorate, handstitch, lace and machine sew leather and fur. The emphasis is on clothing, home furnishings and decorative items with designs and measurements given for a wide variety of projects. Although many readers will think the designs are somewhat "artsy-craftsy", this manual contains

a wealth of information on basic techniques and using leather creatively. 246 pages. **\$8.95 pp**

LEATHER CARE PRODUCTS

RE-100 Belvoir Glycerine Saddle Soap. A famous English formula. 10-ounce bar. Shipping weight 12 oz. **\$1.25**

RE-102 Neat's-foot Oil Compound. A blend of neat's-foot and other oils. One quart. Shipping weight 2 lb. 10 oz. **\$1.45**



FARMER BUNDOLE

A one-pound bundle of scraps—can be lace leather strips, rawhide strips or larger pieces of latigo—but usually has a good variety. Used for repairing pumps, shoes, harness, etc. Shipping weight 1 lb. 4 oz.

FB-1 Farmer Bundle \$1.25

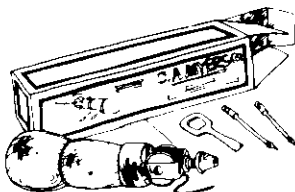

STITCHING AWL

Do your own leather and heavy canvas repairs with this handy gadget. It comes complete with four needles, a spool of thread and instructions for lock-stitch sewing. Shipping weight 8 oz.

SA-1 Stitching Awl \$2.40

Extra Thread. 25-foot skeins available in black, brown or white. 10¢ postage if ordered alone.

SA-1T Extra Thread \$.49

BOOKS

DESIGNING WITH LEATHER & FUR (REAL AND FAKE) by Mary Patton. A very complete introduction to the tools and techniques of creating leather and fur fashions for your home and yourself. 254 pages. Hard cover. **\$8.95**

THE COMPLETE ENCYCLOPEDIA OF NEEDLEWORK by Theresa de Dillmont. With over a million copies in print, this volume is becoming the classic reference tool for both simple and intricate needlecrafts. 987 pages. Paperback. **\$4.95**

HOW TO MAKE CORNHUSK DOLLS by Ruth Wendorff. The inexpensive—and profitable—way to handcraft pilgrims, turkeys, other animals and toys. 77 pages. Hard cover. **\$4.95**

A POTTER'S BOOK by Bernard Leach. Completely covers the potter's art while emphasizing the value of a simple, natural use of materials. 294 pages. Hard cover. **\$12.75**

THE ART OF BLACKSMITHING by Alex M. Bealer. How to work iron by hand and set up your own shop. 425 pages. Hard cover. **\$10.00**

VEGETABLE DYEING by Alma Lesch. The color qualities and subtle blends cannot be duplicated chemically. 151 recipes grouped by color. 146 pages. Hard cover. **\$7.95**

THE ORGANIC WAY TO PLANT PROTECTION by the editors of *Organic Gardening*. An encyclopedic listing of natural controls and repellents for garden pests. 355 pages. Hard cover. **\$7.95**

THE ENCYCLOPEDIA OF ORGANIC GARDENING by J.I. Rodale & Staff. The thousands of listings are alphabetically indexed for instant reference. Step-by-step, easy-to-understand, nontechnical language. 1,145 pages. Hard cover. **\$12.95**

PUTTING FOOD BY by Ruth Hertzberg, Beatrice Vaughan and Janet Greene. Descriptions and charts give in-depth coverage of all the methods of preserving food safely at home. 370 pages. Paperback. **\$4.50**

PASSPORT TO SURVIVAL by Esther Dickey. What foods to stock as emergency rations and recipes for cooking appetizing meals from them. 180 pages. Hard cover. **\$4.95**

STOCKING UP: HOW TO PRESERVE THE FOODS YOU GROW, NATURALLY by the editors of *Organic Gardening and Farming*. Comprehensive explanations of the organic methods of growing, canning, preserving and cooking foods. 351 pages. Hard cover. **\$8.95**

FREEZING AND CANNING COOKBOOK by the Food Editors of *Farm Journal*. Complete instructions for canning and freezing, with favorite tips from homemakers all over the country, and a variety of cook-now, serve-later recipes developed for long-term keeping. 352 pages. Hard cover. **\$6.95**

DRY IT—YOU'LL LIKE IT! by Gen MacManiman. Complete plans for a Living Foods Dehydrator (with a built-in heater and circulating fan, to give uniform results in any season) and a collection of hints on what to do with it. 58 pages plus 6 sheets of plans. Paperback. **\$3.95**

THE RODALE HERB BOOK edited by William H. Hylton. Possibly the most comprehensive and practical guide to herbs: their lore, cultivation and use. 653 pages. Hard cover. **\$12.95**

THE OLD FASHIONED HOMEMADE ICE CREAM COOKBOOK by J. & C. Dueker. Original recipes and how-to for ice cream freaks who like the real thing, made with sugar, milk or cream and pure flavorings and preferably cranked in a freezer (but instructions for producing tasty ices in a refrigerator tray are included). 167 pages. Hard cover. **\$7.50**

THE SUPERMARKET HANDBOOK: ACCESS TO WHOLE FOODS by Nikki and David Goldback. The lowdown on the best nutritional buys in every food category—and by brand names—when shopping in a supermarket. 413 pages. Hard cover. **\$7.95**

HOME PROSPERITY PROGRAM by Vocational Education Enterprises. One of the best handbooks on home business possibilities comes with three supplemental manuals. 212+ pages. Paperback. **\$9.95**

THE OWNER-BUILT HOME by Ken Kern. One of the most detailed, helpful books on constructing a low-cost, contemporary home. 281 pages. Paperback. **\$7.50**

PRACTICAL BUILDING OF METHANE POWER PLANTS by L. John Fry. How to design and build your own displacement-type methane generating plant for home-stand or large-scale use, written by one of the pioneer experimenters and present-day experts. Includes charts, diagrams and photos. 96 pages. Paperback. **\$12.00**

MOTHER'S METHANE PACKAGE: L. John Fry's METHANE DIGESTERS, Ram Bux Singh's BIO-GAS PLANT plus MOTHER NO. 12, 18 and 23, a reprinted (from LIFESTYLE!) set of plans for building a 55-gallon drum methane generator and the Alternative Energy Poster from MOTHER NO. 24. At least a \$13.35 value for \$8.00.

POWER FROM THE WIND by Palmer Cosslett Putnam. A thoroughgoing analysis of the Smith-Putnam Wind Turbine Project—which proved that windplants could be as economical as more conventional facilities—and a comprehensive overview of wind power knowledge up to the year the Project was completed, 1945. Includes optimal sizes and designs for improved models, ways to reduce wind power costs and the future of generating power from this inexhaustible resource. 224 pages. Hard cover. **\$9.95**

BACK ISSUES



Many readers of THE MOTHER EARTH NEWS say that the magazine improves with age. For that reason, all back issues of the publication are perpetually kept in print and can be purchased from the General Store in three ways:

- [1] In yearly sets of six.
- [2] In yearly sets of six with handsome, protective slipcase.
- [3] In yearly sets of six with handsome, protective binder.

In all cases, back issues of THE MOTHER EARTH NEWS are sold for exactly their original cover price. (A premium is never charged for back MOTHERS... as is so frequently the case with other magazines.)

THE MOTHER EARTH NEWS, YEAR ONE: Issues 1 through 6. Including the Special Back-To-The-Land MOTHER and articles on building a dome, cutting hair, living on less, putting up a tipi, free-lance cartooning, low-cost land, home businesses, etc.

Issues 1-6/\$6.70

Issues 1-6 with slipcase/\$10.65

Issues 1-6 with binder/\$11.65

THE MOTHER EARTH NEWS, YEAR TWO: Issues 7 through 12. How to use an axe, eat roses, set up a \$12,000-a-year home business, forecast the weather, buy a used tractor, make vinegar, keep bees, sprout food in a closet and much, much more.

Issues 7-12/\$7.55

Issues 7-12 with slipcase/\$11.50

Issues 7-12 with binder/\$12.50

THE MOTHER EARTH NEWS, YEAR THREE: Issues 13 through 18. Back-tax land, home-spun wool, start a school, build a water wheel, carpet your garden, milk a cow, raise rabbits, make \$40.00 a day with a pickup, build a sod roof, forage food and more.

Issues 13-18/\$8.90

Issues 13-18 with slipcase/\$12.85

Issues 13-18 with binder/\$13.85

THE MOTHER EARTH NEWS, YEAR FOUR: Issues 19 through 24. Build a house of straw, grow onions, sinus cures, cure beef and wild game, bake hardtack, strawberries as a cash crop, farm with oxen, the rammed earth house, wind power, methane, solar energy.

Issues 19-24/\$8.25

Issues 19-24 with slipcase/\$12.20

Issues 19-24 with binder/\$13.20

THE MOTHER EARTH NEWS, YEAR FIVE: Issues 25 through 30. \$1,000-a-month typing business, maple syrup, bulgur recipes, small-town bike shop, solar cooker, operate a car on wood, sex a chicken, comfrey, Ralph Borsodi, herbs, the methane-powered car.

Issues 25-30/\$9.00

Issues 25-30 with slipcase/\$12.95

Issues 25-30 with binder/\$13.95

THE MOTHER EARTH NEWS annual slipcase. Designed to hold all six issues of the magazine published during any one of the periodical's first five years. Rugged, durable and attractively stamped with the magazine's name. **\$3.95 each**

THE MOTHER EARTH NEWS annual binder. All six issues of the periodical printed during any one of the magazine's first five years will quickly and easily mount in this tough, well-made binder. THE MOTHER EARTH NEWS is attractively stamped on both the spine and front cover of each unit. A top-quality binder you'll be proud to own. **\$4.95 each**

Please add 50¢ per yearly set of magazines (with or without slipcase or binder) and 25¢ per individually ordered slipcase or binder for packing and shipping.

THE MOTHER EARTH NEWS® is a registered trademark of THE MOTHER EARTH NEWS, Inc.



MOTHER'S ALMANAC

... a book you
should have!

Conceived, written, edited and illustrated by the staff of THE MOTHER EARTH NEWS®, this lively collection of information includes recipes, home business ideas, money-saving hints, free-for-the-gathering wild foods, land-finding and financing methods, homestead animal-raising tips, organic gardening information, weather lore, recycling projects, games, pastimes, formulas, alternative power concepts, down-home problem solving and satisfying lifestyles for spring, summer, autumn and winter.

It's only \$1.95

... and priced way too low, we've been told. But, it's not the dollars we're interested in... we wanted to get out a nice fat little encyclopedia of knowledge that would be just downright useful to have around. If you haven't already latched onto a copy, we're inviting you to try the ALMANAC on a no-risk, money-back guaranteed basis. Now in its third printing, MOTHER'S ALMANAC has been a sellout in bookstores across the country... and so far only a single copy has been returned to us for a refund. Naturally we're flattered, and we'd like to get the ALMANAC out to all the rest of you folks who'll know how to make use of it. To get your copy, just fill out and return the order form.

We'll send your friends a free copy of MOTHER'S General Store Catalogue.

Got a friend or relative who might be looking for some of those hard-to-find items we stock? Just list their names and addresses below and send them to us. We'll get a fresh copy of this catalogue right off by return mail.

MOTHER'S General Store, P.O. Box 506, Flat Rock, N.C. 28731

PLEASE SEND
THIS FRIEND A
FREE COPY OF
MOTHER'S GENERAL
STORE CATALOGUE

NAME _____

ADDRESS _____

CITY _____

STATE _____ ZIP _____

MOTHER'S General Store, P.O. Box 506, Flat Rock, N.C. 28731

PLEASE SEND
THIS FRIEND A
FREE COPY OF
MOTHER'S GENERAL
STORE CATALOGUE

NAME _____

ADDRESS _____

CITY _____

STATE _____ ZIP _____



THE MOTHER EARTH NEWS®
**HANDBOOK OF
HOMEMADE
POWER**

**ALTERNATIVE ENERGY SOURCES
THAT YOU CAN PUT TO USE NOW!**

Heat your home with the sun! Use the wind to make electricity! Power a shop, house or farm with a water wheel! Run natural gas appliances—even your car—on methane that you produce yourself! Cook on a wood-burning stove! Yes, there ARE answers to the energy crisis . . . and this book tells you how to make them work for you.

To get your copy, use catalogue order form. **ONLY \$1.95**

**We'll send your friends a free copy of
MOTHER'S General Store Catalogue.**

Got a friend or relative who might be looking for some of those hard-to-find items we stock? Just list their names and addresses below and send them to us. We'll get a fresh copy of this catalogue right off by return mail.

MOTHER'S General Store, P.O. Box 506, Flat Rock, N.C. 28731

**PLEASE SEND
THIS FRIEND A
FREE COPY OF
MOTHER'S GENERAL
STORE CATALOGUE**

NAME _____

ADDRESS _____

CITY _____

STATE _____ ZIP _____

MOTHER'S General Store, P.O. Box 506, Flat Rock, N.C. 28731

**PLEASE SEND
THIS FRIEND A
FREE COPY OF
MOTHER'S GENERAL
STORE CATALOGUE**

NAME _____

ADDRESS _____

CITY _____

STATE _____ ZIP _____

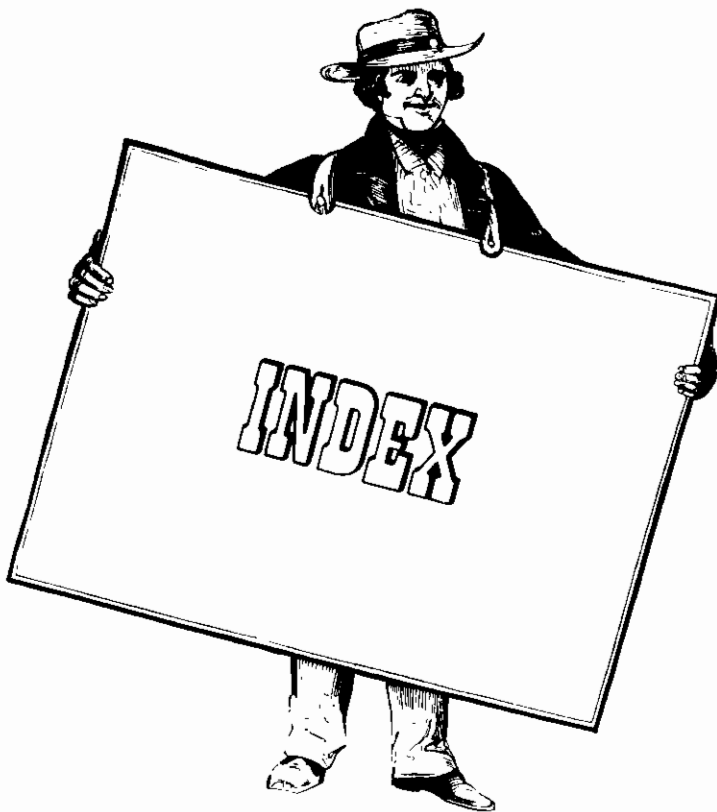

Adze	34	Birdhouses	38	Lifter	14
Air Locks	27	Blanket, Space	66	Bowls, Wooden	8
Animal		Books		Brushes, Hair	47
Repellent	35	Aladdin Lamp	61	Shaving	46
Traps	35	Beermaking	26	Buttermaking Supplies	19
Aprons	51	Bicycling	41		
Automotive Care	39	Children's	44, 45	Calico	51
Awl, Stitching	76	Chinese Cooking	18	Camping Equipment	66-70
Axes	32	Cooking	16	Can, Cream	19
		Craft	75	Candleholders	54, 55
Bags, Bicycle	41	Dulcimer	73	Canning Equipment	9, 14
Compartment	34	Leatherworking	76	Cast-Iron	
Saddle	67	Livestock	29	Cookware	12-13
Shopping	73	Miscellaneous	77, 79, 80	Reproductions	56-57
Sleeping	69	Purple Martin	38	Cheesery, Home	22
Water	66	Winemaking	26	Cherry Stoner	11
Banks, Cast-Iron	56	Bootjacks	49, 57	Chicken Feeders	37
Barber Supplies	46-47	Boots	48-49	Child Carrier	50
Barrels	21, 58	Ordering Information	48	Chopper, Food and Meat	11
Bath Products	52	Bonnets	51	Churn, Electric Butter	19
Beauty Treatments	52	Bottle		Clippers, Hair	47
Bells, Animal	32	Copper	20	Coffee	
Bicycle, High Wheeler	40	Corkers	26, 27	Boiler	8
Big Stinky	29	Cutters	74	Mill	8, 9

Compartment Bag	34	Kettle, Preserving	14	Repellent, Animal	35
Converters, Lamp	60	Kitchen Utensils	8-21	Ricers	15
Cookie Cutters	10	Kite	58	Riveting Machine	76
Cookware, Cast-Iron	12-13	Knapsacks	67	Rocking Horse	44
Corkers	26, 27	Knife Sharpener	17	Root Beer Extract	22
Crafts	74-75	Knives, Barlow	65	Rug	53
Culinary Supplies	8-21	Buck	64, 65	Saddlebags	67
Cultivator	31	Bush	67	Sausage Stuffer	16
Cuspidors	50	Kitchen	17	Attachment	11
Cutlery	17	Skachet	66	Scales	15
Cutters, Bottle	74	Swiss Army	65	Sconces	54, 55
Cookie	10	Kraut Cutter	20	Scoop	32
Corn	15	Lamps, Aladdin	60, 61	Scythe	
Kraut	20	Brooder	37	Blades	30
Dish, Butter	19	Carbide	63	Snath	30
Dolls	45	Cobbler's	54	Sharpening Stones	36
Dome Kits	58	Kerosene	63	Shaving Equipment	46
Doorstops	57	Parts & Accessories	62	Sieve	21
Dulcimers	72	Lanterns, Candle	55	Skachet	66
Fence Tool	34	Electric	55	Skillets	12, 13
Fireplaces	5	Kerosene	63	Sleds	40
Fire Starter	66	Leather Scraps	76	Sleeping Bags (Robes)	68-70
Flutes	72, 73	Leatherworking Tools	76	Liners	68, 69
Flytraps	29	Liners, Sleeping Bag	68, 69	Slicer, Food	16
Food, Survival	28	Livestock Supplies	32-33	Soap	52, 53
Food and Drink	22-23	Looms	74, 75	Shaving	46
Food and Meat Chopper	11	Material, Calico	51	Soil Test Kits	31
Food Slicer	16	Milk Pails	19	Sokotariums	59
Foot Scrapers	57	Mills, Coffee	8, 9	Sole Saver	49
Fountain Pen	73	Grain	11, 16	Sourdough Starter	22
Freezer, Ice Cream	20	Moccasins	49	Spices and Herbs	24-25
Froe	30	Molds, Butter	19	Spinning Wheel	74
Fruit Press	20	Mole Repeller	35	Spittoons	50
Fryers, Fish	13	Mortars and Pestles	25	Spoons, Tea Strainer	23
French	13	Motaloy	39	Wooden	20, 21
Garden Supplies	31	MOTHER EARTH NEWS	83	Sprouts	22
Garden, Survival	29	Almanac	79	Stoves, Wood-Burning	4-7
Garlic Press	11	Back Issues	78	Svea	66
Gift Certificate	75	Energy Book	80	Strops, Razor	46
Grain Mills	11, 16	Mouse Traps	35	Sundials	59
Grate, Fireplace	7	Muffin Pans	13, 57	Survival Food	28, 29
Griddles	12	Mug, Shaving	46	Teas, Herbal	23
Gridle Scraper	17	Musical Instruments	72-73	Tents	70
Grill, Fireplace	7	Neck Duster	47	Timer, Cooking	14
Grinders, Food	11	Night Light	55	Tinware	55
Tool	30	Nippers, Hoof	33	Tipl	67
Gum, Spruce	45	Oilstones	36	Tools	30-34
Hair-Cutting Equipment	47	Ordering Information	3	Farrier's	33
Halters, Cow and Calf	33	Ovens, Dutch	13	Leatherworking	76
Hammocks	71	Packs, Bicycle	41	Toys, Wooden	42-44
Hats	49	Pails, Milk	19	Traps, Animal	35
Hay Hook	32	Pan, Muffin	13	Insect	29
Health Foods	23	Stew	13	Trimmer, Grass	30
Heaters	5, 7	Paper, Recycled	73	Hair	47
Pool	29	Pest Controls	35	Trivet	57
Herbs and Spices	24-25	Pie Plate	10	Udder Balm	33
Home-Brew Kit	26	Pillow	51	Velocipede	40
Honing Kits	36, 64	Pine Tar	33	Vinometer	27
Hook and Knife Stone	36	Pipes, Corncob	50	Waffle Iron	10
Hydrometer	27	Pitchforks	34	Washboards	53
Ice Cream Freezer	20	Poultry Supplies	37	Water Bag	66
Jar Holder and Wrench	14	Press, Fruit	20	Waterstone	36
Jars, Candy	10	Garlic	11	Winemaking Supplies	26-27
Canning	9	Lard/Fruit	16	Woks	18
Spice	25	Pressure Cookers	14	Wooden Bowls	8
Yogurt	23	Purple Martin Houses	38	Wooden Toys	42-43
Kegs	21, 26	Puzzle, Wood	59	Woodenware	21
Kerosene Lamps	60-63	Rain Gauges	31	Yeast, Wine	27
		Rasp, Hoof	33	Yogurt, Culture	23
		Razors	46	Maker	23

Parcel Post Rates

SHIPPING WEIGHT	ZONES							
	Local	1 & 2	3	4	5	6	7	8
up to 2 lbs.	\$0.61	\$0.72	\$0.75	\$0.83	\$0.92	\$1.02	\$1.12	\$1.21
2 lbs. 1 oz. to 3 lbs.	.65	.78	.83	.92	1.04	1.18	1.32	1.45
3 lbs. 1 oz. to 4 lbs.	.69	.84	.90	1.01	1.16	1.33	1.51	1.69
4 lbs. 1 oz. to 5 lbs.	.73	.90	.98	1.10	1.28	1.49	1.71	1.93
5 lbs. 1 oz. to 6 lbs.	.77	.96	1.05	1.19	1.40	1.64	1.90	2.17
6 lbs. 1 oz. to 7 lbs.	.81	1.02	1.13	1.28	1.52	1.80	2.10	2.41
7 lbs. 1 oz. to 8 lbs.	.85	1.08	1.20	1.37	1.64	1.95	2.29	2.65
8 lbs. 1 oz. to 9 lbs.	.89	1.14	1.28	1.46	1.76	2.11	2.49	2.89
9 lbs. 1 oz. to 10 lbs.	.93	1.20	1.35	1.55	1.88	2.26	2.68	3.13
10 lbs. 1 oz. to 11 lbs.	.97	1.26	1.43	1.64	2.00	2.42	2.88	3.37
11 lbs. 1 oz. to 12 lbs.	1.01	1.32	1.50	1.73	2.12	2.57	3.07	3.61
12 lbs. 1 oz. to 13 lbs.	1.05	1.38	1.58	1.82	2.24	2.73	3.27	3.85
13 lbs. 1 oz. to 14 lbs.	1.09	1.44	1.65	1.91	2.36	2.88	3.46	4.09
14 lbs. 1 oz. to 15 lbs.	1.13	1.50	1.73	2.00	2.48	3.04	3.66	4.33
15 lbs. 1 oz. to 16 lbs.	1.17	1.56	1.80	2.09	2.60	3.19	3.85	4.57
16 lbs. 1 oz. to 17 lbs.	1.21	1.62	1.88	2.18	2.72	3.35	4.05	4.81
17 lbs. 1 oz. to 18 lbs.	1.25	1.68	1.95	2.27	2.84	3.50	4.24	5.05
18 lbs. 1 oz. to 19 lbs.	1.29	1.74	2.03	2.36	2.96	3.66	4.44	5.29
19 lbs. 1 oz. to 20 lbs.	1.33	1.80	2.10	2.45	3.08	3.81	4.63	5.53
20 lbs. 1 oz. to 21 lbs.	1.37	1.86	2.18	2.54	3.20	3.97	4.83	5.77
21 lbs. 1 oz. to 22 lbs.	1.41	1.92	2.25	2.63	3.32	4.12	5.02	6.01
22 lbs. 1 oz. to 23 lbs.	1.45	1.98	2.33	2.72	3.44	4.28	5.22	6.25
23 lbs. 1 oz. to 24 lbs.	1.49	2.04	2.40	2.81	3.56	4.43	5.41	6.49

ADD 20¢ FOR EACH ADDITIONAL POUND.

FIND YOUR ZONE NUMBER BY CONSULTING CHART AND DIRECTIONS BELOW

To determine which mailing zone you are in, find the first three digits of your zip code in the left hand column of the following chart. The number in the right column opposite your zip code prefix is your zone number. For example, if your zip code is 87603 the first three numbers are included in 874-884 and your zone is 6. Should your zip code prefix not be in the first chart, check the list of locations at the right of the chart to learn your mailing zone.

Zip Code Prefixes	Zone	Zip Code Prefixes	Zone	Zip Code Prefixes	Zone	Zip Code Prefixes	Zone
000-01	1	00-211	1	437-438	3	77-774	5
000-02	1	00-212	1	439-443	4	77-775	4
000-03	1	00-213	1	444-445	2	77-776	4
000-04	1	00-214	1	446-447	4	77-777	4
000-05	1	00-215	1	448-449	4	77-778	4
000-06	1	00-216	1	450-451	4	77-779	4
000-07	1	00-217	1	452-453	4	77-780	4
000-08	1	00-218	1	454-455	4	77-781	4
000-09	1	00-219	2	456-457	4	77-782	4
000-10	1	00-220	1	458-459	4	77-783	4
000-11	1	00-221	1	460-461	4	77-784	4
000-12	1	00-222	1	462-463	4	77-785	4
000-13	1	00-223	1	464-465	4	77-786	4
000-14	1	00-224	1	466-467	4	77-787	4
000-15	1	00-225	1	468-469	4	77-788	4
000-16	1	00-226	1	470-471	4	77-789	4
000-17	1	00-227	1	472-473	4	77-790	4
000-18	1	00-228	1	474-475	4	77-791	4
000-19	1	00-229	1	476-477	4	77-792	4
000-20	1	00-230	1	478-479	4	77-793	4
000-21	1	00-231	1	480-481	4	77-794	4
000-22	1	00-232	1	482-483	4	77-795	4
000-23	1	00-233	1	484-485	4	77-796	4
000-24	1	00-234	1	486-487	4	77-797	4
000-25	1	00-235	1	488-489	4	77-798	4
000-26	1	00-236	1	490-491	4	77-799	4
000-27	1	00-237	1	492-493	4	77-800	4
000-28	1	00-238	1	494-495	4	77-801	4
000-29	1	00-239	1	496-497	4	77-802	4
000-30	1	00-240	1	498-499	4	77-803	4
000-31	1	00-241	1	500-501	4	77-804	4
000-32	1	00-242	1	502-503	4	77-805	4
000-33	1	00-243	1	504-505	4	77-806	4
000-34	1	00-244	1	506-507	4	77-807	4
000-35	1	00-245	1	508-509	4	77-808	4
000-36	1	00-246	1	510-511	4	77-809	4
000-37	1	00-247	1	512-513	4	77-810	4
000-38	1	00-248	1	514-515	4	77-811	4
000-39	1	00-249	1	516-517	4	77-812	4
000-40	1	00-250	1	518-519	4	77-813	4
000-41	1	00-251	1	520-521	4	77-814	4
000-42	1	00-252	1	522-523	4	77-815	4
000-43	1	00-253	1	524-525	4	77-816	4
000-44	1	00-254	1	526-527	4	77-817	4
000-45	1	00-255	1	528-529	4	77-818	4
000-46	1	00-256	1	530-531	4	77-819	4
000-47	1	00-257	1	532-533	4	77-820	4
000-48	1	00-258	1	534-535	4	77-821	4
000-49	1	00-259	1	536-537	4	77-822	4
000-50	1	00-260	1	538-539	4	77-823	4
000-51	1	00-261	1	540-541	4	77-824	4
000-52	1	00-262	1	542-543	4	77-825	4
000-53	1	00-263	1	544-545	4	77-826	4
000-54	1	00-264	1	546-547	4	77-827	4
000-55	1	00-265	1	548-549	4	77-828	4
000-56	1	00-266	1	550-551	4	77-829	4
000-57	1	00-267	1	552-553	4	77-830	4
000-58	1	00-268	1	554-555	4	77-831	4
000-59	1	00-269	1	556-557	4	77-832	4
000-60	1	00-270	1	558-559	4	77-833	4
000-61	1	00-271	1	560-561	4	77-834	4
000-62	1	00-272	1	562-563	4	77-835	4
000-63	1	00-273	1	564-565	4	77-836	4
000-64	1	00-274	1	566-567	4	77-837	4
000-65	1	00-275	1	568-569	4	77-838	4
000-66	1	00-276	1	570-571	4	77-839	4
000-67	1	00-277	1	572-573	4	77-840	4
000-68	1	00-278	1	574-575	4	77-841	4
000-69	1	00-279	1	576-577	4	77-842	4
000-70	1	00-280	1	578-579	4	77-843	4
000-71	1	00-281	1	580-581	4	77-844	4
000-72	1	00-282	1	582-583	4	77-845	4
000-73	1	00-283	1	584-585	4	77-846	4
000-74	1	00-284	1	586-587	4	77-847	4
000-75	1	00-285	1	588-589	4	77-848	4
000-76	1	00-286	1	590-591	4	77-849	4
000-77	1	00-287	1	592-593	4	77-850	4
000-78	1	00-288	1	594-595	4	77-851	4
000-79	1	00-289	1	596-597	4	77-852	4
000-80	1	00-290	1	598-599	4	77-853	4
000-81	1	00-291	1	600-601	4	77-854	4
000-82	1	00-292	1	602-603	4	77-855	4
000-83	1	00-293	1	604-605	4	77-856	4
000-84	1	00-294	1	606-607	4	77-857	4
000-85	1	00-295	1	608-609	4	77-858	4
000-86	1	00-296	1	610-611	4	77-859	4
000-87	1	00-297	1	612-613	4	77-860	4
000-88	1	00-298	1	614-615	4	77-861	4
000-89	1	00-299	1	616-617	4	77-862	4
000-90	1	00-300	1	618-619	4	77-863	4
000-91	1	00-301	1	620-621	4	77-864	4
000-92	1	00-302	1	622-623	4	77-865	4
000-93	1	00-303	1	624-625	4	77-866	4
000-94	1	00-304	1	626-627	4	77-867	4
000-95	1	00-305	1	628-629	4	77-868	4
000-96	1	00-306	1	630-631	4	77-869	4
000-97	1	00-307	1	632-633	4	77-870	4
000-98	1	00-308	1	634-635	4	77-871	4
000-99	1	00-309	1	636-637	4	77-872	4
000-00	1	00-310	1	638-639	4	77-873	4
000-01	1	00-311	1	640-641	4	77-874	4
000-02	1	00-312	1	642-643	4	77-875	4
000-03	1	00-313	1	644-645	4	77-876	4
000-04	1	00-314	1	646-647	4	77-877	4
000-05	1	00-315	1	648-649	4	77-878	4
000-06	1	00-316	1	650-651	4	77-879	4
000-07	1	00-317	1	652-653	4	77-880	4
000-08	1	00-318	1	654-655	4	77-881	4
000-09	1	00-319	1	656-657	4	77-882	4
000-10	1	00-320	1	658-659	4	77-883	4
000-11	1	00-321	1	660-661	4	77-884	4
000-12	1	00-322	1	662-663	4	77-885	4
000-13	1	00-323	1	664-665	4	77-886	4
000-14	1	00-324	1	666-667	4	77-887	4
000-15	1	00-325	1	668-669	4	77-888	4
000-16	1	00-326	1	670-671	4	77-889	4
000-17	1	00-327	1	672-673	4	77-890	4
000-18	1	00-328	1	674-675	4	77-891	4
000-19	1	00-329	1	676-677	4	77-892	4
000-20	1	00-330	1	678-679	4	77-893	4
000-21	1	00-331	1	680-681	4	77-894	4
000-22	1	00-332	1	682-683	4	77-895	4
000-23	1	00-333	1	684-685	4	77-896	4
000-24	1	00-334	1	686-687	4	77-897	4
000-25	1	00-335	1	688-689	4	77-898	4
000-26	1	00-336	1	690-691	4	77-899	4
000-27	1	00-337	1	692-693	4	77-900	4
000-28	1	00-338	1	694-695</			

Parcel Post Rates

SHIPPING WEIGHT	ZONES							
	Local	1 & 2	3	4	5	6	7	8
up to 2 lbs.	\$0.61	\$0.72	\$0.75	\$0.83	\$0.92	\$1.02	\$1.12	\$1.21
2 lbs. 1 oz. to 3 lbs.	.65	.78	.83	.92	1.04	1.18	1.32	1.45
3 lbs. 1 oz. to 4 lbs.	.69	.84	.90	1.01	1.16	1.33	1.51	1.69
4 lbs. 1 oz. to 5 lbs.	.73	.90	.98	1.10	1.28	1.49	1.71	1.93
5 lbs. 1 oz. to 6 lbs.	.77	.96	1.05	1.19	1.40	1.64	1.90	2.17
6 lbs. 1 oz. to 7 lbs.	.81	1.02	1.13	1.28	1.52	1.80	2.10	2.41
7 lbs. 1 oz. to 8 lbs.	.85	1.08	1.20	1.37	1.64	1.95	2.29	2.65
8 lbs. 1 oz. to 9 lbs.	.89	1.14	1.28	1.46	1.76	2.11	2.49	2.89
9 lbs. 1 oz. to 10 lbs.	.93	1.20	1.35	1.55	1.88	2.26	2.68	3.13
10 lbs. 1 oz. to 11 lbs.	.97	1.26	1.43	1.64	2.00	2.42	2.88	3.37
11 lbs. 1 oz. to 12 lbs.	1.01	1.32	1.50	1.73	2.12	2.57	3.07	3.61
12 lbs. 1 oz. to 13 lbs.	1.05	1.38	1.58	1.82	2.24	2.73	3.27	3.85
13 lbs. 1 oz. to 14 lbs.	1.09	1.44	1.65	1.91	2.36	2.88	3.46	4.09
14 lbs. 1 oz. to 15 lbs.	1.13	1.50	1.73	2.00	2.48	3.04	3.66	4.33
15 lbs. 1 oz. to 16 lbs.	1.17	1.56	1.80	2.09	2.60	3.19	3.85	4.57
16 lbs. 1 oz. to 17 lbs.	1.21	1.62	1.88	2.18	2.72	3.35	4.05	4.81
17 lbs. 1 oz. to 18 lbs.	1.25	1.68	1.95	2.27	2.84	3.50	4.24	5.05
18 lbs. 1 oz. to 19 lbs.	1.29	1.74	2.03	2.36	2.96	3.66	4.44	5.29
19 lbs. 1 oz. to 20 lbs.	1.33	1.80	2.10	2.45	3.08	3.81	4.63	5.53
20 lbs. 1 oz. to 21 lbs.	1.37	1.86	2.18	2.54	3.20	3.97	4.83	5.77
21 lbs. 1 oz. to 22 lbs.	1.41	1.92	2.25	2.63	3.32	4.12	5.02	6.01
22 lbs. 1 oz. to 23 lbs.	1.45	1.98	2.33	2.72	3.44	4.28	5.22	6.25
23 lbs. 1 oz. to 24 lbs.	1.49	2.04	2.40	2.81	3.56	4.43	5.41	6.49

ADD 20¢ FOR EACH ADDITIONAL POUND.

FIND YOUR ZONE NUMBER BY CONSULTING CHART AND DIRECTIONS BELOW

To determine which mailing zone you are in, find the first three digits of your zip code in the left hand column of the following chart. The number in the right column opposite your zip code prefix is your zone number. For example, if your zip code is 87603 the first three numbers are included in 874-884 and your zone is 6. Should your zip code prefix not be in the first chart, check the list of locations at the right of the chart to learn your mailing zone.

Zip Code Prefixes	Zone	Zip Code Prefixes	Zone	Zip Code Prefixes	Zone	Zip Code Prefixes	Zone
006 000	1	94 000	3	417 438	1	711 714	4
0 0000	1	98 231	3	439 449	4	7 11 717	4
007	6	98 000	3	450 471	3	718	3
008 000	1			458 460	4	719 720	4
068 000	1	100 303	3	470 472	3	727	1
		60	1	473 474	4	728	4
100 118	4	100 207	1	475 477	2	729 704	2
104 26	7	108 1 5	7	478 485	4	730	4
113	1	1	4	496 499	4	731 784	5
1 18 129	5	1 1 325	3			785	4
100 112	4	100 329	1	504 1 1	5	786 78 5	5
131 136	7	130 134	5	120	4	788	6
133 143	4	135 138	4	512 1 1	5	789	2
104	3	139	5	526 518	4	790 793	6
150 100	1	150 852	1	528 504	1	791	5
		165 1 1	4	561	4	792 794	5
100 27	4	165 1 1	3	500 573	5	793 794	5
218 2 76	3	161 1 1	4	1 1 588	6	794 791	6
233 238	4	168	3	590 592	1		
218 231	1			794	6	811 814	5
241 43	1	170 372	1	598 598	6	815	1
244 247	3	172 171	7			816 820	6
248 246	3	1 6	1	606 634	4	817	7
249 251	4	177 1 4	7	625	5	818 823	4
254	1	180 184	4	176 130	4	824 827	5
259 257	4	183 181	4	640 648	5	826 824	6
268 259	4	186 19	4	650 674	4	829 834	7
				658 676	4	835 838	6
100 106	4	200 426	1	671	1	840 865	7
247	1	407 429	2	678 689	3	871 871	6
268 728	3	410 412	1	690 671	6	271	7
2 1 1	4	411 418	4			874 884	6
780 784	1	430	1	780 762	4	890 894	7
283 287	1	431 423	3	785 786	4	896 897	8
284	1	437 426	2	787 788	4	898	7
287 288	1	437 410	3	710 711	5		
289 293	2	413 416	4	712	4	900 900	8

Postal Zone Chart

The following are wholly within the indicated zone

Alaska	8
Arizona	7
California	8
Canada Zone	8
Canton Islands	8
Caroline Islands	8
Delaware	4
District of Columbia	4
Guam	8
Hawaii	8
Illinois	4
Mariana Islands	8
Marshall Islands	8
Massachusetts	5
Michigan	4
Minnesota	4
Mississippi	4
Missouri	4
New Hampshire	4
New Jersey	4
North Dakota	4
Oklahoma	5
Oregon	6
Puerto Rico	7
Rhode Island	5
Samoa (American)	8
Utah	4
Vermont	5
Virgin Islands	7
Wake Island	8
Washington State	8

A GOOD LIFE...A GOOD LIVING!

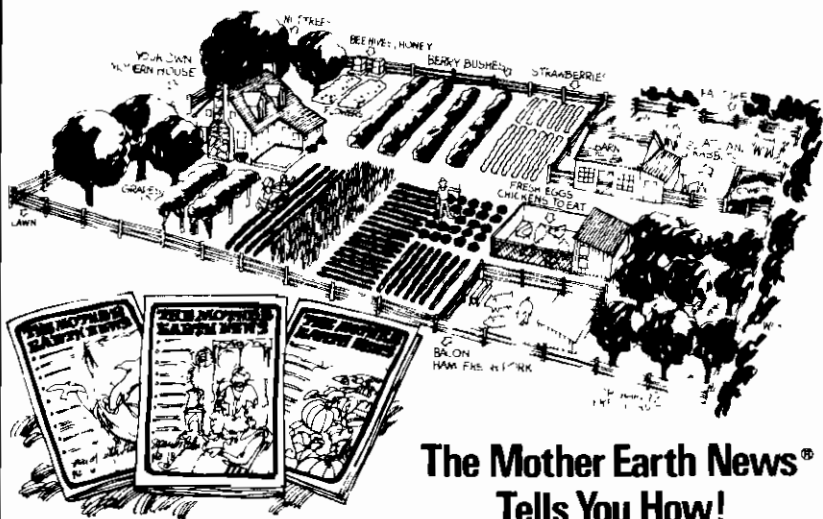

The Mother Earth News® Tells You How!

But what is MOTHER anyway: a magazine or a book? Well, neither . . . and both. She's more of a serialized survival manual for the future and packed with articles that really tell you how. How to find and finance low-cost land, for instance, and set up your own little family homestead. How to raise a garden naturally, without poisons or pesticides. How to can, preserve and freeze your own fruits, vegetables and fresh meats. How to raise goats, chickens, bees, pigs, geese, ducks, sheep and other homestead animals. How to start your own home business, recycle "junk" into useful items and—in general—live better for less while doing exactly what you *want* to do.

If you're trying to put the rat race behind you, breathe free and build a better, richer more satisfying life for yourself, your family or your tribe . . . you'll find MOTHER to be required reading. Order out a subscription and see for yourself. There's absolutely no risk. If you don't love MOTHER, just tell her so . . . and she'll send you your money back!

YES! Send MOTHER to me.

- ONE YEAR \$ 8.00
(6 issues)
- TWO YEARS 14.00
(12 issues)
- THREE YEARS 20.00
(18 issues)

Payment
Enclosed \$ _____

NAME _____

ADDRESS _____

CITY _____ STATE _____ ZIP _____

THE MOTHER EARTH NEWS® • P.O. Box 70, Hendersonville, N.C. 28739

Box 506, Flat Rock, N.C. 28731

ADDRESS CORRECTION REQUESTED
RETURN POSTAGE GUARANTEED



If you received more than one copy of this catalogue

... we apologize. We try not to be wasteful, but we're not yet perfect in keeping track of the thousands of names and addresses on our mailing lists. If you received an extra copy, you can help us salvage that precious paper and postage by passing the catalogue along to a friend or neighbor. We'd be mighty grateful.

BULK RATE
U.S. POSTAGE
PAID

THE MOTHER
EARTH NEWS®

69242-31-1/76
COMM FOR SOC MAMTS COLL
B 395X, NEWCOMB HALL STA.
Charlottesville, VA 22903