

~~TOP SECRET~~ **REDACTED** CY

ANNEX B
to
APPENDIX C

AIRBORNE OPERATIONS

Page

		1
		2
		3
		4
		5
		6
		7
		8
		9
		10
		11
		12
		13
		14
		15
		16
		17
		18
		19
		20
		21
		22
		23
		24
		25
		26
		27
		28
		29
		30
		31

PART II. RESOURCES (U)

GROUP 1

Excluded from automatic
downgrading and declassi-
fication

JS-306 (JS-279)

	<u>Page</u>	
F. (TS) <u>TRAINING</u>	C-b-14	<u>1</u>
1. (TS) General	C-b-14	<u>2</u>
2. (TS) Recruiting	C-b-14	<u>3</u>
3. (TS) Training - Camp Long Thanh	C-b-17 ^e	<u>4</u>
4. (TS) STRATA Team Training - 1968	C-b-33	<u>5</u>
G. (TS) <u>COMMUNICATIONS</u>	C-b-33	<u>6</u>
1. (TS) Project BUGS	C-b-33	<u>7</u>
2. (TS) Resupply Communications	C-b-34	<u>8</u>
PART III. OPERATIONS (U)		C-b-35
A. (TS) <u>INTRODUCTION</u>	C-b-35	<u>10</u>
B. (TS) <u>BACKGROUND</u>	C-b-35	<u>11</u>
C. (TS) <u>GENERAL CONDUCT OF OPERATIONS</u>	C-b-35	<u>12</u>
1. (TS) Mission	C-b-37	<u>13</u>
2. (TS) Exfiltration	C-b-37	<u>14</u>
3. (TS) Resupply	C-b-37	<u>15</u>
D. (TS) Long - Term Agent Team Operations	C-b-38	<u>16</u>
1. (TS) Operations - 1964	C-b-38	<u>17</u>
2. (TS) Operations 1965 - 1967	C-b-41	<u>18</u>
3. (TS) Operations 1968 - 1969	C-b-49	<u>19</u>
4. (TS) Long-Term Agent Team Chronology	C-b-52	<u>20</u>
E. (TS) <u>STRATA TEAM OPERATIONS</u>	C-b-62	<u>21</u>
1. (TS) General Conduct of Operations	C-b-62	<u>22</u>
2. (TS) Mission Narratives 1967 - 1968	C-b-67	<u>23</u>
3. (TS) Mission Summary	C-b-76	<u>24</u>
4. (TS) STRATA Targets	C-b-76	<u>25</u>
5. (TS) Target Locations	C-b-76	<u>26</u>
F. (TS) <u>SINGLETON OPERATIONS</u>	C-b-83	<u>27</u>
1. (TS) Policy	C-b-83	<u>28</u>
2. (TS) Goldfish and Pergola	C-b-83	<u>29</u>
3. (TS) Gray Singleton Operations	C-b-83	<u>30</u>
		<u>31</u>

	<u>Page</u>	
G. (TS) <u>DIVERSIONARY OPERATIONS</u>	C-b-85	<u>1</u>
1. (TS) Project Oodles	C-b-85	<u>2</u>
2. (TS) Project Urgency	C-b-85	<u>3</u>
3. (TS) Project Borden	C-b-87	<u>4</u>
H. (TS) <u>EARTH ANGEL</u>	C-b-87	<u>5</u>
PART IV. PROBLEM AREAS (U)	C-b-90	<u>6</u>
A. (TS) <u>PROBLEM AREAS - AIRBORNE OPERATIONS</u>	C-b-90	<u>7</u>
B. (TS) <u>CHRONOLOGY</u>	C-b-90	<u>8</u>
PART V. EVALUATION (U)	C-b-96	<u>9</u>
A. (TS) <u>SACSA EVALUATION - 1964</u>	C-b-96	<u>10</u>
B. (TS) <u>COMUSMACV EVALUATION - 1966</u>	C-b-97	<u>11</u>
C. (TS) <u>BROWNFIELD REPORT 1967- 1968</u>	C-b-101	<u>12</u>
D. (TS) <u>SECURITY REVIEWS</u>	C-b-103	<u>13</u>
E. (TS) <u>CINCPAC STRATA TEAM EVALUATION</u>	C-b-106	<u>14</u>

ANNEX B TO APPENDIX C

AIRBORNE OPERATIONS

PART I. BACKGROUND

A. ~~(TS)~~ INTRODUCTION

This Annex describes in some detail Airborne operations from 1964 until June 1969. Included, in addition to the study and evolution of the original long-term agent teams, is the development of the STRATA Teams, employment of singleton agents, and the later development of the diversionary program. These operations were referred to as Airborne operations, or Agent Team operations, until the code word TIMBERWORK(C) was assigned in 1967. The meanings of other code words appearing in this Annex can be found in Tab A to the general section of this volume.

B. ~~(TS)~~ INITIAL POLICY

1. ~~(TS)~~ Transfer From CAS. [REDACTED]

[REDACTED]

[REDACTED]

With the formation of SOG in early 1964, the Airborne Operations Section replaced a similar element of the CAS organization. Airborne operations assumed responsibility for [REDACTED] North Vietnam, the Camp Long Thanh training facility [REDACTED]

[REDACTED] and several safe houses in Saigon.*

2. ~~(TS)~~ Mission. The first mission statement for the airborne section was, "to assist and supervise ARVN counterparts in the accomplishment of small demolition operations, small-scale intelligence collection, temporary interdiction of lines of communication, limited psychological operations, and creation of general harassment in DRV as set forth in OPLAN-34A."*

1.5(e)
3.4(b)(1)

1.5(e)
3.4(b)(1)

* ~~(S)~~ History, MACSOG, "Annex A to MACV Command History 1964," p. II-8. (SACSA)

C. ~~(TS)~~ EVOLUTION OF MISSION AND OBJECTIVES

1. ~~(TS)~~ General. The mission and effectiveness of the long term agent teams were in a state of continuous reevaluation from 1965 until the summer of 1968, when all teams were judged as probably compromised. During this period of time, thinking changed from the belief that the teams represented a valuable asset in accomplishing SOG's mission to the later opinion expressed by CINCPAC that the long-term agent teams were a "complete failure in terms of the useful intelligence produced."* In the paragraphs that follow, the mission changes will be traced and the policies outlined that supported the missions. For a summary of evaluation material, see Part IV of this Annex.

2. ~~(TS)~~ 1965 Developments

a. New Op-Order. The mission given to the Airborne Section of MACSOG by CINCPAC** in the October 1965 Op-Order reflected the evolution of SOG's mission to emphasis on intelligence collection:

"34-A guerrilla in-place teams and teams to be infiltrated into NVN will conduct intelligence, sabotage, psychological, and [redacted] 34-A teams are authorized to recruit and support local agents in NVN for intelligence and [redacted] Physical destruction operations may be conducted against selected targets by 34-A guerrilla teams providing security of intelligence and E&E nets is not jeopardized."**

This mission statement led to the development of meaningful, long-range programs of activating operational areas for intelligence gathering around major routes leading from NVN into Laos.***

b. EWOTS. The Early Warning Observation Teams (EWOTS) concept was developed in 1965 to meet the requirement of the changing mission. MACSOG proposed**** that EWOTS/Roadwatch Operations be

* ~~(TS)~~ Msg, CINCPAC, DTG 160437Z Nov 68. (SACSA)
** ~~(TS)~~ Msg, CINCPAC "34A Basic Op Order", DTG 300241Z Oct 65. (SACSA)
*** ~~(TS)~~ History, MACSOG, "Annex N to MACV Command History 1965," p. II-A-4. (SACSA)
**** ~~(TS)~~ Msg, MACV, DTG 160712Z Oct 65.

undertaken as a matter of priority in areas south of 20° and that future reinforcement efforts be built around the need to increase team viability and provide capabilities for an expanded intelligence collection. The scope of this effort was to include surveillance over enemy major roads from NVN into Laos.

1
2
3
4
5
6

c. Helicopter Infiltration Concept. The fixed wing aircraft (C-123) available to SOG in 1965 were unsatisfactory for accurately placing and resupplying agent teams.

7
8
9



10
11
12
13
14
15
16

1.5(e)
3.4(b)(1)

3. (T) 1966 Policy

17

a. New Program. In May 1966, MACSOG published a comprehensive review of OPLAN-34A operations and proposed objectives and programs for the subsequent 15 months.** A brief summary of the proposals for airborne operations is outlined below.

18
19
20
21

(1) As originally conceived, airborne operations (infiltration teams) were intended to build a resistance movement in NVN which would, "exert pressure against the NVN Government, divert resources and make continuous support of the war in RVN less attractive."** As discussed earlier in this report, the implementation of the resistance movement was never authorized at the Washington level and, therefore, airborne operations were conducted under ambiguously worded mission statements that permitted sabotage, interdiction and harassment in NVN.***

22
23
24
25
26
27
28
29
30

** (T) Report, MACSOG, "SOG Missions, Objectives and Programs FY-4/66-FY-67 (U)," 10 May 66. (SACSA)

*** (T) Ibid., p. 6-7.

(2) The program reviewed the interest DIA and the Joint Chiefs of Staff had taken in the capability of SOG agent teams to obtain intelligence. Concern over possible CHICOM intervention, infiltration of DRV forces into South Vietnam, and Soviet and CHICOM military aid to NVN prompted a reorientation of the teams mission. "It was determined that maximum emphasis should be placed upon intelligence collection and establishment of civilian contacts with secondary emphasis on psychological operations, [redacted] and sabotage."*

1
2
3
4
5
6
7
8
9

(3) Based on this re-evaluation, the following concept was prepared for CINCPAC approval.

10
11

"(a) Develop an operational area astride every major LOC leading from NVN into Laos and emplacing operational teams in these areas.

"(b) Reorient all in-place teams to the primary mission of intelligence collection by roadwatch, rail-watch, and riverwatch.

"(c) Develop civilian contacts in every operational area to expand the intelligence base and provide limited logistical support, thus lessening team reliance on external support.

"(d) Limit operations initially to the development of new operational areas and at the same time make inoperative teams viable again."*

(4) To implement the new concept, team training was altered to place primary emphasis on intelligence gathering. Three types of operational teams were being trained as shown in the brief summary below:

12
13
14
15

Type	Strength	Mission
A	10 agents	Roadwatch/early warning observation. Organize safe areas. Prepare to receive reinforcements.
B	5 agents	Reinforce Type A team. Establish civilian contacts. Organize and operate intelligence nets. Conduct PSYOPS.
C	10 agents	Reinforce Types A and B teams. Team adds limited strike/interdiction capability to operational area.**

* (TS) Ibid, p.7-8.

** (TS) History, MACSOG, "Annex M to MACV Command History 1966," p.58. (SACSA)

"Each new operational area was to be developed initially by infiltrating a Type A team, reinforce successively by Type B and C teams. Planning provided for further reinforcement as required by broadened missions and/or operational losses."*

b. Seismic Devices and Project BUGS. The emphasis in 1966 on intelligence collection prompted CINCPAC to direct SOG to equip OPLAN-34A teams with Seismic Intrusion Devices (SSID) for emplacing along NVN Routes 103, 137, 15, 1 and to provide teams with immediate roadwatch intelligence reporting by radio -- Project BUGS.**

c. Chinese Agents. In a 1966 memorandum***, the Joint Chiefs of Staff discussed the difficulty in recruiting quality personnel for agent team operations.

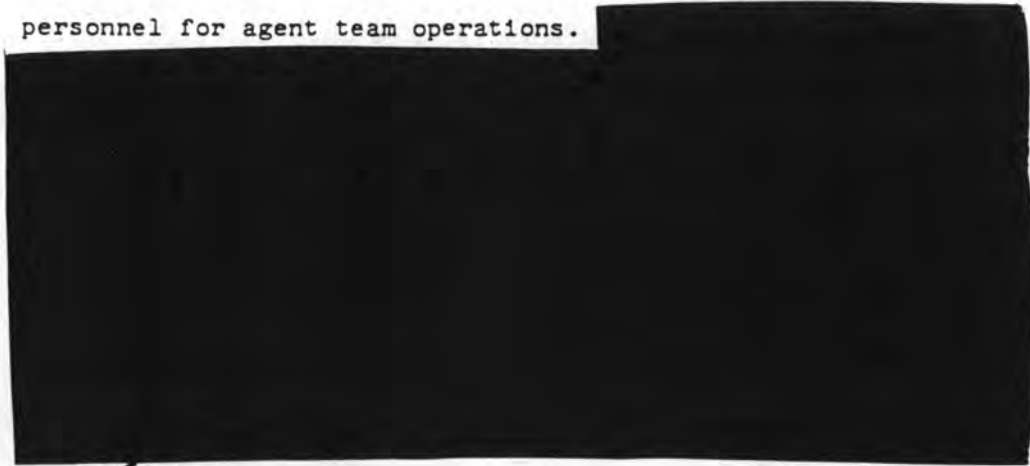

4. (TS) 1967 Developments

a. Development of EWOTS/STRATA Concept. The EWOTS concept was first proposed in 1965. The initial purpose of the teams was to infiltrate the area between the 17th and 19th Parallel in NVN to give warning of a CHICOM build-up. This concept was expanded in response to the need for expanded intelligence collection effort in NVN as expressed by DIA. As finally approved,**** the EWOTS/Roadwatch operations were authorized south of the 20th Parallel on a priority basis with later

* (TS) History, MACSOG, "Annex M to MACV Command History 1966," p.58. (SACSA)

** (TS) Ibid., p.60.

*** (TS) Memo, CJCS to SECDEF, "CHINAT Agents for OPLAN 34A Teams (TS)," 10 Nov 1966. (SACSA)

**** (TS) Msg, CINCPAC, DTG 272139Z Oct 65.

emphasis above the 20th parallel. The task was to be
accomplished by adding specially trained intelligence personnel
to existing teams as well as introducing new teams. It was
envisioned that the operation would include surveillance of
every major road from NVN into Laos. The teams would be put
in place by helicopters whenever feasible. The Short-Term
Roadwatch and Target Acquisition (STRATA) team concept was
approved by the Joint Chiefs of Staff on 7 April 1967,* with
concurrence of the State Department. Only two of eight long-term teams infiltrated
into the area between 17°-19° North latitude had
survived since 1964.**It was believed that the emphasis on
short stay time and mobility in the STRATA team training would
enable them to survive and to be successfully exfiltrated.
The approved operational area extended from the northern limit
of the DMZ to within 50 miles of the CHICOM border and to a
depth of 50 nm from the Lao/NVN border. Initial efforts were
to be concentrated in the area between the DMZ and 19°N
latitude (see Figure B-___). In May 1967, the northern portion
of the DMZ was included in the operational area.***. STRATA
teams were to be composed of 5-15 indigenous personnel trans-
ported by USAP/RVNAF helicopter to Laos or NVN and then over-
land to a base camp in NVN. Missions were to be 15-30 days.
On 31 August 1967, CINCPAC approved the first nine STRATA team
targets.****

b. Objectives Plans and Programs. CINCPAC's revised basic
op-order of April 1967# was augmented by the follow-on objec-
tives plans and programs for FOOTBOY(C) published by MACSOG in
May 1967 for FY 1968. The concept of operations is somewhat
detailed, but is quoted here to illustrate the thinking of
MACSOG at that time on agent team operations (TIMBERWORK(C)).

* (T) Msg, JCS, DTG 071804Z Apr 67. (SACSA)
** (T) Memo, CJCS to SecDef, "Special Operations-STRATA Team Concepts
(S)", 23 Mar 67.
*** (T) Msg, JCS, DTG 241940Z May 67. (SACSA)
**** (T) Msg, CINCPAC, DTG 312216Z May 67. (SACSA)
(T) Msg, CINCPAC, DTG 252340Z Apr 67. (SACSA)

FIGURE

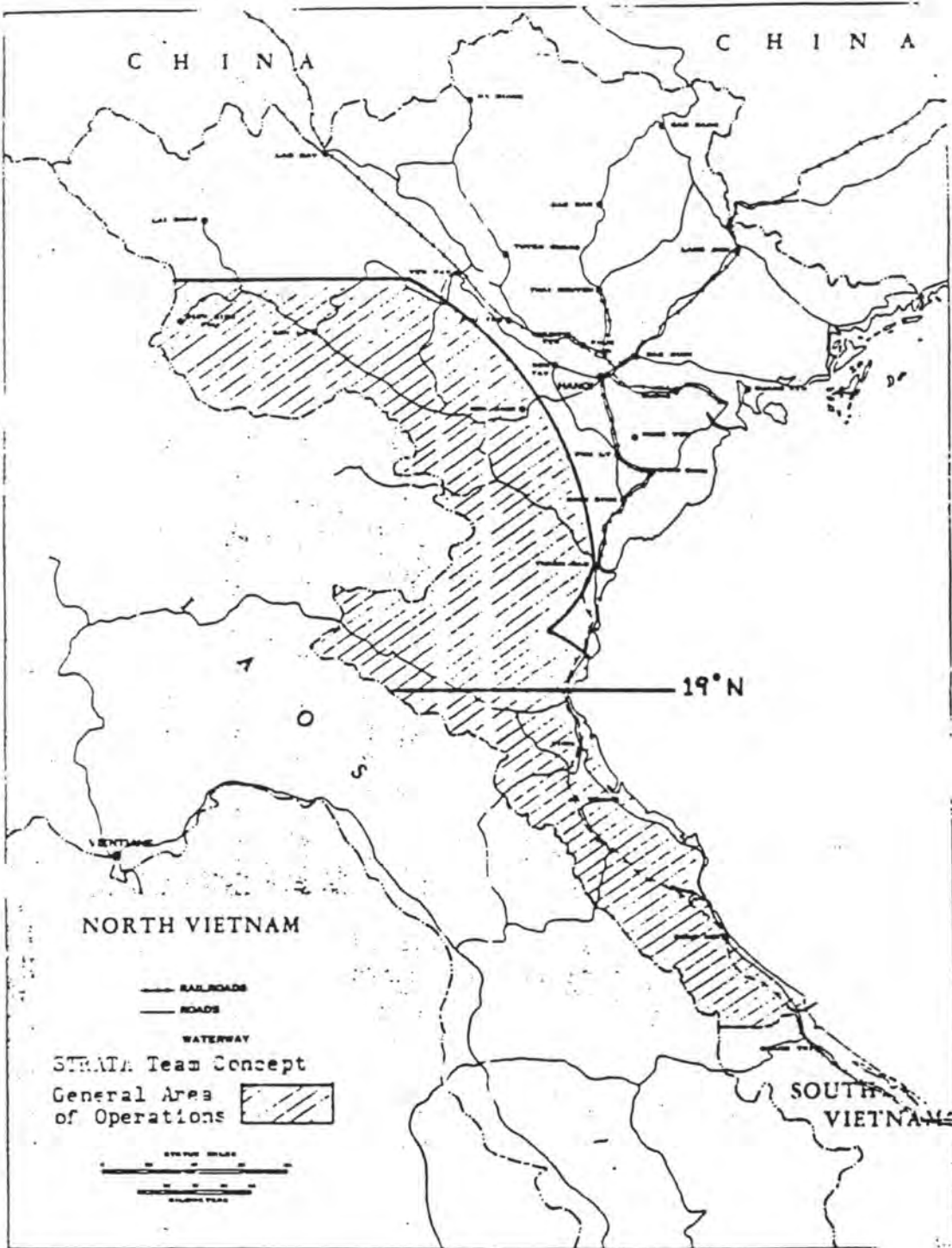

(1) "Concept. Personnel indigenous to the area of intended employment are recruited and trained for employment in selected operational areas located generally astride major LOC leading from Central NVN into Laos and in other critical areas as required. Agent teams infiltrated into areas in the west and northwest develop resistance/guerrilla forces as authorized among susceptible tribal groups and exploit these forces to conduct guerrilla warfare, intelligence, psychological and E&E operations. Operations are conducted under the guise of the Sacred Sword Patriots League (SSPL). Infiltration, reinforcement, resupply and recovery of personnel are principally by air. In-place assets in Laos and NVN assist with infiltration and establishment of initial contacts as feasible. Raids and ambushes are used to interdict LOC, harass local NVN forces, and to draw the NVA into a counterinsurgency role. Controlled air strikes are directed against significant targets and strike results reported. Intelligence collection tasks include river, rail, road and trail watch. Teams expand potential resistance/guerrilla forces and extend their areas of influence or control as the situation permits. In the more closely controlled areas of the Delta and along the coast, individual agents or small agent teams are infiltrated to contact vulnerable groups, e.g., Catholics, and establish resistance organizations to perform intelligence and psychological operations functions. ... In all areas, friendly evading personnel and NVN defectors are secured and evacuated when possible. All operations are conducted so as to permit plausible denial by US/RVN."*

(2) It was planned that the missions for agent teams and STRATA teams would be conducted by 15 in-place agent teams, representing 100-150 agents, and 6-10 STRATA teams, representing 150-200 agents.*

c. Diversion Operations. Diversion operations were initiated in November 1967.

"In support of TIMBERWORK (C) guerrilla team operations, it was planned to convince the enemy that there were more teams inside NVN than actually existed. The goal of this program was to establish 18 notional teams by September 1968."**

5. ~~(TS)~~ 1968 Mission and Restrictions. The mission of airborne operations in 1968 was stated as follows:

"The TIMBERWORK (C) program has the mission of collecting military intelligence through cross-border agent operations and conducting diversionary agent operations designed to deceive enemy security forces and dissipate their resources."***

* ~~(TS)~~ Program, MACSOG, "FOOTBOY(C) FY 68 Program (C)," 10 May 1967, p.7-8.
** ~~(TS)~~ History, MACSOG, "Annex G to MACV 1967 Command History," p. G-III 4-6. (SACSA)
*** ~~(TS)~~ History, MACSOG, "Annex F to MACV Command History 1968 (U)," p. F-III-4-1.

1
2
3
4
5
6
7
8

a. Types of Operations, 1968. Three types of operations were conducted in support of the mission. 1
2

(1) Agent Team Operations. Agent team operations functioned as before with a primary responsibility for intelligence collection and secondary responsibility for target acquisition, [redacted] early warning, selective harassment, psychological operations and [redacted]. 3
4
5
6
7

(2) STRATA Operations. STRATA operations had been approved in April 1967. Only two STRATA teams were infiltrated in 1967. Twenty-four (24) teams were infiltrated in 1968. 8
9
10

(3) Diversionsary Operations. Diversionsary operations were conceived under the code name of FORAE (C) in late 1967. 11
12

The objectives of these operations were: 13

"...to divert main force NVN resources to defense and internal security, divert them away from actual clandestine operations, increase the strain on control of the populace, create opportunities for friendly psychological operation, exploitation, harass the enemy in his rear, and collect intelligence where possible."**

b. Bombing Halt Limitations, 1968

"Major significant changes in the TIMBERWORK (C) program in 1968 were caused by the April restriction on air operations north of 20°N, by a security assessment in June which evaluated all the then in-place teams as probably under NVN control, and by the 1 November halt of air activities north of 17°N."**

* (TS) History, MACSOG, "Annex F to MACV Command History 1968 (U)," p. F-III-4-1.
** Ibid. p. F-III-4-2, F-4.

PART II. RESOURCES (U)

A. (TS) GENERAL

Part II, Resources, describes the organization of the Airborne Section of SOG, facilities available, and training conducted at Camp Long Thanh and Forward Operating Base (FOB) Danang. As in many other areas of MACSOG activities, detailed information on the early organization and training within the Airborne Section is not as complete as the records covering the later period of activity.

B. (TS) ORGANIZATION

The organization for airborne operations in 1967 is described in the "Brownfield"* report as being under MACSOG operations officer (OP-30). OP-34 (Airborne Operations) was a staff element under the operations officer that had the responsibility for planning, training, and employment and operational control of agents/agent teams employed against NVN. The airborne operations group included the teams and agents and physical assets under the operational control of OP-34.

1. (TS) Diagram. A simplified organization diagram for the Airborne Section was as follows:

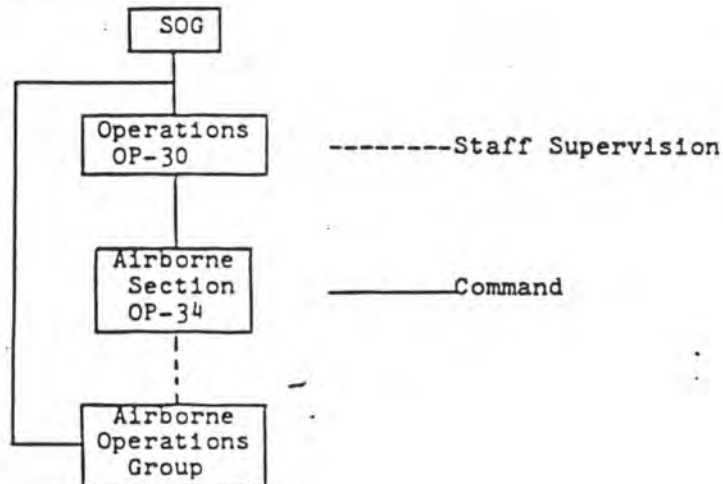

* (TS) Report, MACJ-3, "Ad Hoc Evaluation Group Report," 14 Feb 1968, TIMBERWORK (C), p.1. (SACSA)

2. (TS) Counterpart Organization. The Strategic Technical Directorate (STD), counterpart to SOG, was organized in a broad sense much as SOG was organized. Group 68 of STD was the counterpart of the Airborne Operations Group.

3. (S) Function of the Organization. The planning and coordination of OP-34 in 1967 was described in the Brownfield report as carrying out the following functions:

a. Recommended to CINCPAC and the Joint Chiefs of Staff specific target areas for the employment of agents/agent teams.

b. Prepared concept of the operations.

c. Coordinated with other MACSOG staff elements to obtain area intelligence, EEI desires, logistical support for special items of equipment, airlift support for infiltration, exfiltration and resupply; establishment of bomb lines around team, radio frequencies, for air/ground communications, cryptographic material, and Forward Air Control (FAC) aircraft.

d. Coordinated planning and mission execution with STD.

e. [REDACTED]

f. Coordinated mission with CAS through CAS technical adviser on the OP-34 staff.

g. Operational control of all teams was exercised by OP-34.*

4. (TS) Reorganization - 1968. Operations commenced in 1968 with OP-34 divided into three branches: OP-34A, agent team operations; OP-34B, STRATA operations; and OP-34C, diversionary operations.

The chief of OP-34 was also responsible for the FOB at Danang (Monkey Mountain, FOB), the Joint Translation Center, Hanoi (headquarters for OP-34 and STD counterparts), numerous [REDACTED] in Hanoi and had staff supervision over Camp Long Thanh. On 18 November, STRATA assets were passed to OP-35 for cross-border operations. In the December reorganization of SOG, Camp Long Thanh was designated as the SOG training command and placed under a new training directorate

* (S) Ibid., p.4.

on MACSOG staff. OP-34 became a staff section with the title of Ground Operations Studies Branch. The Airborne Studies Group was redesignated OP-36 and became a command directly responsible to SOG, with headquarters in the Joint Translation Center. The reorganization took the operational control of TIMBERWORK(C) assets out of the hands of the staff (formerly exercised by OP-34) and placed it in the hands of OP-36, one of several commands under the new organization.* OP-36 was then organized as follows:

1
2
3
4
5
6
7
8
9

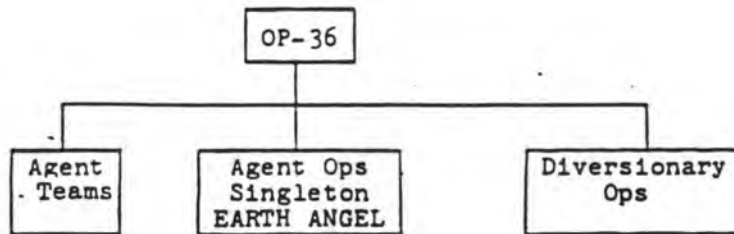

C. ~~(TS)~~ RESOURCES AVAILABLE

10
11
12
13
14
15
16
17
18
19
20
21
22
23
24
25
26
27
28

The resources utilized by the Airborne Section in late 1967 was as follows**:

1. ~~(TS)~~ Personnel

a. US (OP-34)-(Included instructors) 13 officers; 33 enlisted men; one civilian (CAS).

b. GVN (STD) (included instructors) - 28 officers; 26 enlisted men; 403 civilian.

c. Long Term Agents - nine teams, 54 agents.

d. STRATA Team Agents - 25.

2. ~~(TS)~~ Physical

a. Training facility Camp Long Thanh.

b. Staging area (isolated area) Black Rock.

c. FOB Danang.

d.



* ~~(TS)~~ History, MACSOG, "Annex F to MACV Command History 1968," p. F III-4-1. (SACSA)
 ** ~~(TS)~~ Report, MACJ-3, "Ad Hoc Evaluation Group Report," 14 Feb 1968, TIMBERWORK(C), p.2. (SACSA)

- 3. (U) Major Items of Equipment
 - a. 210 Weapons (pistols and rifles)
 - b. 199 pieces of radio equipment
 - c. 67 pieces of photographic equipment
 - d. Office and miscellaneous equipment

- 4. (U) Vehicles
 - a. One sedan
 - b. 16 1/4 ton trucks
 - c. Three 1/2 ton trucks
 - d. Seven 3/4 ton trucks
 - e. Eight 2 1/2 ton trucks

D. ~~(TS)~~ AGENT CLEARANCES

A procedure for processing clearances for proposed agents was set up within SOG. The SOG Liaison Bureau and Security Section was responsible for checking with local police, district chief, and American sources and setting up a dossier of various completed forms on each agent. MACSOG Directive No. 604 (Series) contained detailed procedures.

E. ~~(TS)~~ AGENT PAY AND ALLOWANCES

1. (TS) General. The amount of pay and method of payment were important considerations in the ever present problems of promoting good morale and motivation among agent personnel. A summary of the basic pay for the various agent categories is covered below. For more detail on this subject, see the "Standard Operating Procedures for Airborne Operations Study Group" in the SACSA file.

2. ~~(TS)~~ Method of Payment. Personnel and pay records for agent personnel were maintained by the counterpart organization (STD). SOG Finance provided STD Finance a lump sum each month from which agents were paid. A record of all agent pay was then furnished SOG. The individual agent received his pay through the STD case officer concerned. If an agent did not designate another person to receive his pay while the agent was on a mission, the case officer deposited the pay in a savings account of a reputable bank until the agent returned to STD/SOG control.

3. ~~(T)~~ Pay Scales

a. Base Pay. Base pay per month for all agent personnel, civilian or military, was as follows:

- (1) Team leader - 16,000\$ VN
- (2) Assistant team leader - 14,000\$ VN
- (3) Team member - 12,000\$ VN

b. Mission Pay. For short-term missions (10 days or less), 1,000\$ VN per day; for long-term missions (over 10 days), 10,000\$ VN per month.

c. Military Differential Pay. The Vietnamese military personnel received differential pay which equalized their total earnings with civilian agents.*

d. Family Allowances. Agents who were head of a family were authorized 600\$ VN per month for his wife and 400\$ VN per month for each child under 16.

e. Recruitment and Inducement Bonus. As set forth in the MACSOG Civilian Personnel Manual, Part II.

f. Radio Operator Bonus. A fully qualified team radio operator received a one-time bonus of 5,000\$ VN.

g. Extraordinary Recognition Reward. As recommended by Chief, OP-36 for approval by Chief SOG/Director STD.

h. Prisoner of War Pay, Missing in Action Pay, Disability Gratuity, Funeral Gratuity, Death Gratuity, and Per Diem. See SOP**for details.

i. Singleton Agent Pay. A special arrangement for singleton pay and allowances was approved by SOG in 1969. A one-time payment was made to the agent upon his return from a mission to SOG control. No provision was made for dependent payments. Singleton agents in training were quartered and fed by STD/SOG. In addition to the base pay, singleton agents could be awarded a bonus up to 50,000\$ VN depending on the value of information collected on his mission. A summary follows:

* US SOP, Airborne Studies Group, 28 Mar 1969, p. 14,31. (SACSA)
** (T) Ibid., p.33-38. (SACSA)

- Base Pay - 100,000\$ VN (Maximum)
- Family Allowance - None
- Tet Bonus - None
- Operational Pay - None
- POW/MIA - None
- Death Gratuity - None
- Performance Bonus - 10,000\$ VN (Maximum)*

F. (TS) TRAINING

1. (TS) General. Training for agent team operations was conducted at Camp Long Thanh, Monkey Mountain FOB, and in [REDACTED]. As outlined earlier, Camp Long Thanh was under the direction of OP-34 until December 1968.

a. Camp Long Thanh. For detailed discussion of program of instruction and problem areas, see a later section.

b. Monkey Mountain. Monkey Mountain FOB Danang was used as an isolation facility and a launch point for realistic field training for long-term agent teams and, later, the STRATA teams.

c. Safe Houses. The [REDACTED] were utilized for training, billeting, and messing long-term agent/agent teams and singleton agents. Formalized training included: intelligence collection, weapons, hand-to-hand combat, communications, first aid and survival training. Teams were parachute trained at Camp Long Thanh; field exercises were conducted at Monkey Mountain. The training cycle varied in length from two to six months depending on trainees ability and background and the target date for team deployment.

2. (TS) Recruiting. The problem of recruiting suitable personnel as agents for airborne operations plagued MACSOG from the beginning. The following statement from the 1964 period expressed a problem that was never solved:

* (TS) Ibid., P.14 (SACSA)

"Inability of STS to recruit high quality individuals for agent training has forced the deployment of mediocre teams."*

a. The initial plan for recruiting of agents was divided into three phases as shown below:

(1) Phase I

(a) Indirect Contact. Come in contact with representatives of local area of recruitment for pre-investigation, identification, and collection of preliminary information concerning possible agents for the program. Establish the list of candidate agents.

(b) Desired Qualities. Good health, qualified for jump training. Aged between 21 and 35. Having no more than two children. Being not the main support of the family or the only son. Evidence sought to guarantee anti-communist spirit (e.g., having relative killed by Viet Cong or being ex-cadre of SVN government). Being adventurous people such as: hunters, divers, woodcutters who are familiar with hard life. Being of primary education level or usual readers of daily newspapers.

(2) Phase II. Direct contact with candidate agent to confirm foregoing points. Candidate agent should volunteer to comply with discipline and withstand hardship in training and on mission. Agent may go on mission in-border for a period of one or two years.

(3) Phase III. Case officer contact candidate agent once more to be sure that he has fully understood and accepted the conditions stated above.**

b. 1966, No improvement. The continuing nature of recruiting problems was emphasized by the following statement:

"During the year, it became increasingly difficult to recruit agents selectively for OPLAN 34A Airborne Teams. The difficulty principally stems from a general scarcity of qualified indigenous personnel, the competition for high caliber individuals posed by the Vietnamese civilian economy, and the huge drainage of manpower for military service. Desertion among agent trainees continued to be a problem, and has had an adverse effect on the ability to maintain team unity. The AWOL/

* (S) History, MACSOG, "Annex A to MACV Command History 1964,"

p. II 19,21. (SACSA)

** (T) Ibid., p. II-F-2,3. (SACSA).

desertion rate among agent trainees increased from eight percent during March to 21 percent in May. This, coupled with the lag in the recruiting during that period, curtailed the formation of new teams, which in turn resulted in a slippage in the 15 Month Deployment Program. Some of the agent recruits soon became disenchanted with the prospect of operating as intelligence agents in NVN. Further compounding the situation is the hard fact that thus far none of the attempts to bring OPLAN 34A Airborne Teams out of NVN has been successful. In an effort to improve the recruiting and retention programs, the Airborne Operations Section coordinated with STS (RVN counterpart organization) to increase agents' pay and allowances, provide generous provisions for survivors benefits and disability pay, improve the quarters and training facilities, issue better clothing and equipment, and place greater emphasis on motivational indoctrination. Further, a research proposal was submitted to the Advanced Research Projects Agency for a socio-psychological study of Indochinese ethnolinguistic groups to develop diagnostic/apptitude tests or screening devices. If successfully developed, these should make possible a rapid and reliable identification of such groups which present a high risk of being psychologically ineffective as intelligence agents or operatives. Additionally, some success has been achieved in recruiting prospective agents in Laos. Hopefully, this recruiting effort may be expanded; however, clearance from CAS Vientiane must be obtained to implement any recruiting plans in Laos.**

c. Ethnolinguistic Study. The Ethnolinguistic Study referred to above was awarded to the American Institute for Research, Pittsburgh, in June of 1967. The original cost estimate for the study was \$200,000; however, following a preliminary survey by a research team for the company, a new expanded study at a cost of \$832,000 was proposed. Neither MACV nor CINCPAC felt that the potential value of the study was worth the high cost. CINCPAC cancelled the project in February 1968.** (A copy of the research proposal, June 1967, is available in the SACSA files.)

d. Recruiting Procedures - 1967-1968.

(1) Sources. Agents were recruited from refugee centers in Laos and South Vietnam, from military units, POW camps, Chieu Hoi centers, and from prisoners captured in the maritime operations. The responsibility for identifying and recruiting candidates was assigned to STD Group 68. One STD officer was on permanent duty in Laos, but recruitment of personnel from this area with the basic qualifications required to develop reliable and efficient agents was unsatisfactory.***

* (S) History, MACSOG, "Airborne Operations," 1966 MACV Command History, p. 74.
 ** (S) Msg, CINCPAC, DTG 070403Z Feb 68. (SACSA)
 *** (S) Report, MACJ-3, "Ad Hoc Evaluation Group Report," 14 Feb 1968, TIMBERWORK(C), p.9. (SACSA)

(2) Processing. A Personnel Record Questionnaire and a Name Trace Request was prepared on each prospective agent to facilitate a security check through the Vietnamese National Police, the American Embassy, and the MACV security section. Processing through these agencies took from two to four weeks and identified prospective agents who had a criminal, former agent, VC suspect or undesirable record. In addition, operational personnel had a physical examination by the SOG surgeon and were subjected, conditions permitting, to a polygraph test.*

e. Recruiting Problems - 1967-1968

(1) 1967

"As in previous years, the interrelated problems of recruiting and retention continued during 1967. By becoming more selective, SOG accepted a temporary reduction in the input of new personnel. However, all operational needs were met from agents already on hand or obtained, in small numbers, during the year. The stress of selectivity was intended to produce agent trainees who were highly motivated, therefore, more easily retained, and who were more capable of accomplishing difficult and hazardous missions assigned to them. Whether or not the new system of recruiting established at the end of 1967 would solve the basic problems of personnel selection would be answered in the following year."**

(2) 1968 Agent Teams. In-country recruiting was limited to ten agents: two singleton agents and one eight-man strategic intelligence team that was not deployed to NVN before the November restrictions.

"Third-country recruiting /also/ proved unsatisfactory during 1968. The principal effort, in Laos, resulted in recruitment of personnel unsuitable for duty as agents for a variety of reasons, principally health and lack of ability to be trained as intelligence agents. In addition, the program was found to be compromised and monitored by the NVN Embassy; and was therefore discontinued in September."***

(3) 1968 STRATA Teams. STRATA recruiting efforts in early and mid-1968 were sporadic and unrewarding, partially due to the director of STD personally turning down the majority of the applicants as being too young or unexperienced. Those

* (73) SOP, Airborne Studies Group, 28 March 1969, p.42 (SACSA).
 ** (73) History, MACSOG, "Annex G to MACV Command History 1967," p. G III-4-26, 27.
 *** (73) History, MACSOG, "Annex F to MACV 1968 Command History" p. F III-4-4 -

personnel who did enter training, were predominantly deserters from CIDG forces. Toward the latter part of the year, a sustained effort was undertaken to recruit from the military. ARVN officers and NCOs began to enter training in larger numbers. STD remained responsible for spotting and recruiting throughout the year and quality of the STRATA recruit showed definite signs of improvement until the 1 November bombing halt.*

1
2
3
4
5
6
7
8
9

(4) 1968 Diversionary Operations

(a) "Project URGENCY(C) recruiting was accomplished through HUMTIDOR(C) SSPL assets on DODO Island solely by SID. More intelligent NVN fishermen were approached in such a manner that they would not be suspected by other fishermen. Those fishermen suspected of being penetrators, NVN cadre or in other ways not cooperative, were unwittingly recruited for pseudo-agent missions and secretly implicated as agents."

10
11
12
13
14

(b) "Project BORDEN(C) recruiting was done by US personnel from only US division level detention facilities to allow speedy collection and avoid compromise. Authority to collect detainees from normal detainee channels was obtained from MACV J2... Detainees were selected based on four criteria: NVA, healthy, literate, and cooperative. VC were included for the first time in Group 98 which was collected and and trained in December."**

15
16
17
18
19

3. (7b) Training - Camp Long Thanh

a. History. The airborne operations training center was officially named Quat Thang Camp; the Americans called it camp Long Thanh. The air strip and road network were built by the

20
21
22
23

* (7) Ibid.
** (7) Ibid p# III-4-5.

Handwritten notes:
11/11/68



Japanese in 1943. In March 1963, the RVNAF High Command assumed control of Camp Long Thanh from Binh Hoa Sector. The camp at that time had seven companies of civilian combatants. Two new programs were initiated at Camp Long Thanh with a 12 man Special Forces "A" Team plus a four man augmentation acting as cadre. The two programs were the Combined Military Operations Studies (MOS) and Combined External Operations Studies (EOS). MOS trained four Ranger companies for cross-border operations. EOS trained agent teams for employment in North Vietnam. Initially, groups of six to eight agents were trained in [REDACTED]. When a program of instruction (POI) was developed at Camp Long Thanh, agents were trained there in groups of 30-40 men. During February 1964, a Special Forces "A" Team, augmented with four men and commanded by Captain Kelly, arrived. [REDACTED] was in charge of Long Thanh until the arrival of Captain Cutolo in March. Captain Cutolo supervised a crash construction program to bring the training and security facilities up to a level to meet requirements. By the end of 1964, the camp was capable of housing and instructing 250 civilian volunteer students.*

b. Original Syllabus. The 1964 syllabus was divided into three phases.

(1) Phase I was scheduled for a total of seven weeks of introductory instruction in the fields of communications, medical, weapons, psychological operations, and three weeks of basic airborne training. Students who did not meet minimum standards were dropped from the program.

(2) Phase II was a period of four weeks devoted to specialization in one of the general subjects covered in Phase I.

(3) Phase III was a four-week schedule devoted to field exercises designed to expose students to all facets of previous training.**

* (23) History, MACSOG, "Annex A to MACV Command History 1964," p. II-16 (SACSA).
 ** (23) Ibid., p. II-18.

1.5(e)
3.4(b)(1)

c. 1965 Organization. The US advisors were organized along functional lines with S1, S2, S3 and S4 sections. There was also an organization of training committees to handle the various subjects presented. These subjects were:

- (1) Intelligence/psychological operations
- (2) Map Reading, land Navigation and Survival
- (3) Tactics
- (4) Demolition
- (5) Weapons
- (6) Air Operations
- (7) Medical

This "Program of Instruction" was designed to take approximately 21 weeks and included a leadership evaluation program designed to assist in the future selection of team leaders.*

d. 1967 Revision. The syllabus was revised in 1967 into three major areas: (1) field operation; (2) special techniques; and (3) special subjects. Emphasis was placed on developing the first STRATA teams. The number of US personnel (advisors) varied over the year from a low of 18 in June to a high of 42 in January. The VN cadre at the camp ranged between 46 and 60 over the year.**

e. 1968 Review

(1) General. The training of all OP-34 teams (mainly STRATA teams) and singleton agents continued to be conducted primarily at Camp Long Thanh. Field training was conducted near Camp Long Thanh and in the vicinities of Dalat and Danang (Monkey Mountain FOB area). The syllabus for team training was based on a program of instruction developed by the senior advisor, Camp Long Thanh (SALT), based on guidance from Chief OP-34. (Singleton agent training was based on a

* (S) History, MACSOG, "Annex N to MACV Command History 1965," p. IIA-D-1-14. (SACSA)

** (T) History, MACSOG, "Annex G to MACV Command History 1967," p. G III-4-E-2-2. (SACSA)

specific syllabus developed by case officers geared toward the needs of the agent and his mission.) All training included intelligence collection techniques, observation, target analysis, elicitation techniques, reporting, operational security, cover and subjects relating to infiltration and exfiltration.*

(2) Instructors and Syllabus. The US advisors at Camp Long Thanh averaged 30 in number during 1968. They were organized functionally into sections: S-1, S-2, S-3, S-4. There was also an organization of training committees with US advisors assigned. The committees were:**

(a) Field Operations

1. Weapons
2. Intelligence
3. Tactics

(b) Special Techniques

1. Medical
2. Communications
3. Demolitions
4. Psychological Operations

(c) Special Subjects

1. Basic Airborne Course
2. River Crossing
3. Skyhook
4. Message Pickup

The average strength of the VN instructor cadre during 1968 was approximately 30.

(3) Long-Term Teams Trained

(a) Team VANG's four members had originally been the Vietnamese members of Team NANSEN. Team NANSEN exfiltrated into Laos in May 1967; Team Vang commenced refresher

* (TS) Historical Summary, Airborne Studies Group, "SOG Annual Historical Summary," 5 Jan 69, p. 80. (SACSA)

** (TS) Ibid., p. 106-107.

training as a new team in January 1968. In May 1968, it was decided by SOG intelligence that the location proposed as an operating area for VANG was not suitable for black team operations. -Subsequently, the team was turned over to the STRATA program for one mission. After the STRATA mission the team resigned.*

1
2
3
4
5
6

(b) Team QUA was a six-man team recruited in Laos. Two members were given partial training as radio operators, but did not return after requesting emergency leave in May 1968. The other four members were trained for three months but were declared physically unfit and returned to Laos in September 1968.*

7
8
9
10
11
12

(c) Team AXE was a team of [redacted] and two VN radio operators. The team was trained in early 1968 and transferred to the STRATA program after the 1 April bombing restriction. Three members were lost on missions and the others were separated from the program because of poor health and resignations.**

13
14
15
16
17
18

(d) RED DRAGON ALPHA was planned as a two-man reinforcement element for Team RED DRAGON. The two men were turned over to the STRATA program and subsequently lost on a mission in NVN.**

19
20
21
22

(e) Team 915 was a nine-man team composed of ethnic North Vietnamese that commenced training in October 1968. Its first mission was not until 1969. This team along with 919, which commenced training in early 1969, were retained under the operational control of the Airborne Studies Group.***

23
24
25
26
27
28

(f) STRATA team basic training was conducted at Camp Long Thanh.***

29
30

* (S) Ibid., p. 81.
** (S) Ibid., P. 82
*** (S) Ibid., P. 81, 82

(g) BORDEN(C) agents, part of the diversionary program (FORAE(C)), were trained in an exclusion area of Camp Long Thanh in two phases. The first phase, from 10-21 days, included processing, screening, and orientation. The object of this phase was to assess the potential agents, screen out unsuitable candidates, and gain the cooperation of those retained in training. The training in the phase emphasized orientation in: _____

"...the objectives of the project, the freedom and prosperity to be gained in the RVN, and many other ideological themes such as the resistance of the Vietnamese people to domination, the necessity for free world forces in South Vietnam, what communism means to Vietnam, the Chieu Hoi program and other subjects designed to gain the students cooperation. ...Throughout this phase, unsuitable candidates were returned to normal unit detention facilities but were utilized to spread specific project information among other detainees. This information magnified the size and success of the project and was expected to reach NVN security elements and cause a countering reaction. The second phase was from 7 to 14 days and included basic agent and mission training. Basic training was composed of security, reporting, navigation, inducing defection through use of an ultraviolet secret Chieu Hoi mark, infiltration techniques (helicopter or parachute), rewards, and obligations. Mission training included specific tasks, cover, documentation, and other special subjects as needed (communication, use of dead drops, etc.). All training was kept isolated from other SOG operations. Basic training and all but specific tasks of mission training were conducted in groups to purposely compromise the agents among themselves. They were normally utilized as singletons, where possible, to obtain the maximum effect. Inducing defection by marking potential defectors with UV paste that they were told was a secret Chieu Hoi pass was their primary mission. Collection of intelligence was secondary. Exfiltration, unless specifically planned otherwise, was by defecting again to free world forces."*

- f. Current Program - Camp Long Thanh
- (1) Camp Long Thanh became the SOG training command (OP-38, Training Study Group) under the staff cognizance of OP-30 (Operations Training and Studies) in late 1968. Commencing in the fall of 1968, for the first time, team leaders and

* (T) Ibid., P. 84.

Special Commando Unit (SCU) personnel from the cross-border operations were trained at Camp Long Thanh. Formerly, this training had been conducted at the Command and Control Centers. Camp Long Thanh had concentrated on training long-term agent teams, STRATA team, and singleton agent personnel.

(2) A Special Forces B Detachment with seven officers and 24 enlisted assigned provided the guidance to VN counterparts who actually conducted the training. The operating cost of the camp was approximately one million dollars a year.

(3) Figure B-1 shows the number of students trained and the cost of training each student at Camp Long Thanh over a four-year period.

(4) Figure B-2 is a summary of Camp Long Thanh training information including an ethnic breakdown and the AWOL rate.

(5) Figure B-3 is a list of the courses offered at Camp Long Thanh in mid-1969.

(6) Figure B-4 is a diagram of the organization and command relationships in the summer of 1969.

(7) The back-up file for this Annex in SACSA has copies of the Program of Instruction for the Camp Long Thanh courses being given in 1969. Photographs of the camp and various ethnic groups in training are also in the file.

g. Camp Long Thanh Problem Areas. The significant problems encountered by the SALT over the years are cataloged below:

(1) 1964

FIGURE B-1 (S)

CAMP LONG THANH STUDENT OUTPUT
(BASED ON AN AVERAGE OPERATIONAL EXPENDITURE OF \$37,500.00 PER MONTH)^{A/}

YEAR	STUDENT OUTPUT	COST OF TRAINING EACH STUDENT
1966	746	\$ 603.00
1967	66	6,818.00
1968	353	1,275.00
1969 (1 JAN...30 JUN)	868	259.00

^{A/} RECENT PAY RAISES HAVE BOOSTED THE AVERAGE MONTHLY EXPENDITURES OF CAMP LONG THANH TO APPROXIMATELY \$40,000.00 PER MONTH AS OF JULY 1969. ESTIMATED TOTAL LOST FOR PHYSICAL YEAR 1969 IS:

JAN THRU JUN 69 =	\$224,000
JUL THRU DEC 69 =	240,000

SUB TOTAL \$464,000

ALL OUTSIDE SUPPORT - LOGISTICAL, MAINTENANCE, CONSTRUCTION, ETC.	500,000
---	---------

TOTAL FOR FY 1969 \$964,000

~~TOP SECRET~~

FIGURE B-2 (T)
CAMP LONG THANH TRAINING SUMMARY

Year	Ave. No Teams in Training	Ave. Ethnic Breakdown	Ave. Student Strength	Ave. AWOL Rate/Mo.	Remarks
1964	15	Not Avail.	192	Not Avail.	
1965	15	VN-9 Muong-1 Nung-1 [REDACTED] Thu-2	191	12	
1966	10	VN-4 Comb-4 ^a / Dual-2 ^a / 	138	3.6	
1967	8	VN-4 Comb-1 ^a / Dual-3 ^a / 	93	.7	April- STRATA Training Commenced
1968	4	VN-2 Cambodian-2	65	NA	

^a/ Comb - More than two ethnic groups; e.g., (NN, Tho, [REDACTED], Nung, etc.)
Dual - VN+one other ethnic group in most cases. Some dual teams of Tho/Nung and Nung/Mung.

~~TOP SECRET~~

C-b-25

Annex B to
Appendix C

~~TOP SECRET~~

FIGURE B-3 (TS)
TRAINING ACTIVITIES - 1969
CAMP LONG THANH

Courses	Length
US Reconnaissance Team Leaders School	17 Days
Vietnamese Reconnaissance Team Leaders School	17 Days
Special Commando Unit Basic Training	5 Weeks
US Exploitation Force (Leaders School)	2 1/2 Weeks
Vietnamese CW Communications	16 Weeks
Vietnamese Reconnaissance Team Member Medical Course	1 Week
US Basic Airborne Course	3 Weeks
US Airborne Refresher	1 Day
Vietnamese Basic Airborne Course	3 Weeks
Special Jump Techniques (Ex. Tree Jumping)	2 Weeks
Vietnamese Basic Agent/Long Range Training (STRATA)	8 Weeks
Vietnamese Specialized Agent Training (STRATA Advanced Course)	2 Weeks
Civilian Irregular Defense Group Basic Training	2 Weeks

~~TOP SECRET~~

C-b-26

Annex B to
Appendix C

FIGURE B-4 (S)

ORGANIZATION AND COMMAND RELATIONSHIPS FOR CAMP LONG THANH, TRAINING STUDIES GROUP (OP-38) (U)

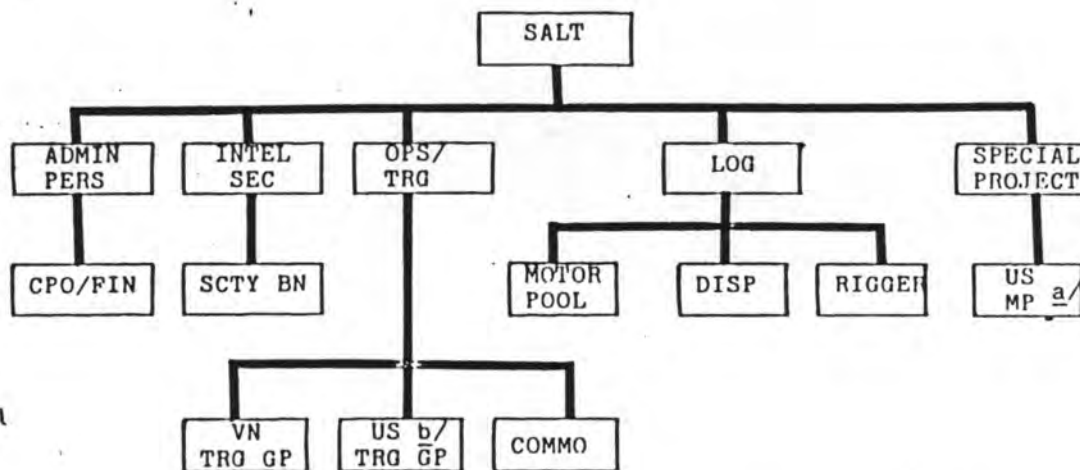

a/ In addition to Det B-53 personnel, Special Projects include TDY personnel from OP-36, 18th Military Police Brigade and the 519th Military Intelligence Battalion.

b/ In addition to Det B-53 personnel, the US training group also includes personnel TDY from OP-35 and the C&C Detachments.

(a) Inability of STS to recruit high quality individuals for agents training forced the deployment of mediocre teams. 1
2

(b) Agents were not isolated after they had commenced training. Several teams who had actual mission briefings had been allowed to go on leave immediately after their missions aborted. 3
4
5
6

(c) Viet Cong had a large intelligence network. They, in spite of security checks, probably had spies among the agents, cadre, security battalion, and civilian workers at Long Thanh. 7
8
9
10

(d) Camp Long Thanh was in an active VC area. Considerable effort was required to maintain local physical security. 11
12

(e) Communications with Long Thanh during critical mission periods was subject to compromise. 13
14

(f) Several agent teams had been captured in DRV. From radio Hanoi reports and International Control Commission (ICC) publications, it is evident that DRV had a good working knowledge of Long Thanh operations.* 15
16
17
18

(g) Discipline 19

1. The discipline of the students at Camp Long Thanh was poor. Contributing factors were 20
21

a False recruiting promises which led students to expect preferential treatment. 22
23

b Belief of the cadre and STS that civilian students could not be subjected to military discipline even though contracts state that they were. 24
25
26

c Fear of some members of the ARVN cadre to discipline students. 27
28

d Reluctance of STS to discard poor students. 29

* (S) History, MACSOG, "Annex A to MACV Command History, 1964" (SACSA)

e Lack of close supervision caused the the students to fend for themselves in order to settle problems. The students believe that had a right to collective bargaining with the cadre.

f Failure to enforce existing regulations and and punishments.

g Belief that the agents were all going to die anyway has caused the agents and some of the cadre to believe that the agents should enjoy themselves while they had the opportunity.

h Trained teams after waiting for months for deployment often become stale and hard to handle.

i Recruiting of individuals who had questionable reputations in their home communities brought known discipline problems to Camp Long Thanh.

j Agent leaders held popularity (with the students) over mission accomplishment.

2 The following actions were instituted to improve the discipline:

a Set and enforce standard punishments.

b Development of procedure to draft unacceptable students in the Army upon expulsion from the agent program.

c A pre-course basic training period to identify and eliminate individuals of poor potential.

d Assignment of one cadre sergeant per barracks to control the students as well as handle their problems.

e US and ARVN cadre were required to set the example with appropriate dress and bearing.

f Attempts were made to raise recruiting standards. Individuals with good service experience were preferred.

(2) 1965

(a) Strategic Technical Service (STS). The STS organization for Camp Long Thanh did not provide enough depth in instructor personnel, and in some cases, some of the Vietnamese Instructors were not qualified. Through close coordination between SALT and the Vietnamese Camp Commander, requests went forward through both US and Vietnamese channels for additional qualified instructors. Those instructors who were not qualified to instruct were placed in Assistant Instructor slots in order to allow them to learn their subjects.

(b) Discipline. Throughout 1965 the program was continually hampered by the lack of discipline among the students. In the past, the Camp Commander did not have sufficient power to properly handle the cases of students who had committed offenses, and also the students status was that of a civilian. Action was taken to correct this deficiency by setting up a new list of offenses with appropriate punishment which the Camp Commander could enforce at his level, and also Chief OP-34 prepared a legal agreement which students could understand and sign before entering the program. The document spelled out the powers of the Camp Commander, and punishment which could be applied for various offenses.

(c) Interpreter Procurement and Retention

1. The rapid build-up of US Forces in Vietnam resulted in an acute shortage of interpreters, and interpreter procurement became highly competitive. Although MACSOG interpreter pay scales compared favorably with other agencies few competent interpreters would consider employment at Camp Long Thanh due to the unattractive location and demanding duty requirements:

2. All interpreters utilized by this activity were civilians, and as such they received no government recognition or credit toward their service obligation for duties performed regardless of how arduous or hazardous they may have been. Consequently, many were understandably reluctant to

work in locations where they would have been subjected to enemy fire or participate in hazardous operational or training missions. The problem is particularly acute in the recon teams of the 35A program. SOG is aware of this problem and a search for qualified interpreters is constantly being conducted.

1
2
3
4
5
6

(d) Procurement and Retention of Civilian Irregular Defense Group (CIDG) Personnel

7
8

Due to inflationary trends in the Vietnamese economy CIDG pay scales were no longer adequate to attract personnel, and recruiting efforts in the last months of 1965 were almost complete failure. Due to attrition and desertions, the Security Battalion was reduced to 70% of authorized strength. CIDG personnel were able to obtain employment as guards with other units and installations in the Saigon area with comparable pay and without the risks and discomforts of the Security Battalion. A recruitment program is continually being conducted to enlist personnel in the CIDG ranks.

9
10
11
12
13
14
15
16
17
18

(e) Air Support

19

Lack of air support in some instances caused a decline in training. Training was planned on numerous occasions which required infiltration and exfiltration by H-34 helicopter. In many cases, information would be received the day prior to scheduled training that a requested H-34 helicopter was not available, thereby hindering an important phase of training. Lack of C-123 aircraft at the required times greatly hindered the training of CP 34A students. Time and again the cancelling of aircraft on the day it was scheduled caused rapid revamping of scheduled training.

20
21
22
23
24
25
26
27
28
29

(3) 1967

30

(a) Air Support

31

On numerous occasions throughout the year air transportation or resupply was planned for an operation and was not available at the time needed. This resulted in unrealistic activities conducted for students who expected to infiltrate under realistic conditions in hostile areas. The

31½
32
32½
33
33½

many occasions that air support was planned resulted in plans made and then cancelled which caused serious deflation of student morale after being told that they would get all the support they needed.

(b) Discipline

(a) Students continued to go AWOL throughout the year. The Camp Commander attempted to solve the problem by confining students who went AWOL to a makeshift jail. No apparent success resulted through these measures.

(b) The majority of the problems stemmed from the fact that the students were civilians who were never exposed to real military discipline. A secondary reason for the high AWOL rate was the lack of a specific program of instruction and activities. The students became bored with constant refresher training. *

(4) 1958

(a) The inability to get air support for training on numerous occasions throughout the year has a serious effect on student morale and training realism.

(b) Discipline. Students continued to go AWOL or quit just prior to going on actual operations throughout the year. The principal reasons were:

1. Most students were civilians who were not accustomed to military discipline.

2. The students did not sign a contract which would obligate them to serve for a length of time or participate in operational missions.

3. Student screening by STD was too harsh at times and too liberal at others.

* (16) History, MACSOG, "Annex G to MACV Command History 1967," p G III -4-27, 28 (SACSA).

4. Students did not have a draft exempt status. Some 1
were picked for the draft while on pass or leave. 2

(c) VN Cadre personnel were not able to instruct in any 3
area except their specialty. * -- 4

4. (TS) STRATA Team Training - 1968. "Training of STRATA teams, 5
after completion of the basic course at CLT, and once operationally 6
ready and transferred to Monkey Mountain FOB (MMFOB), Danang, became 7
the responsibility of the MMFOB Commander and his VN counterpart. 8
During the summer (SW Monsoon) months when STRATA insertions were 9
at their height, training at Danang consisted primarily of specific 10
pre-mission and refresher training. During the last quarter of the 11
year, when first the NE Monsoon and then the bombing halt slowed 12
and then stopped missions in NVN, MMFOB training was characterized 13
by a series of field training exercises in the Dalat area of RVN 14
with the purpose of: (a) improving the teams' efficiency in communi- 15
cations, land navigation, reporting, and forward air guide procedures, 16
(b) maintaining the teams' operational readiness, and (c) preparing 17
the teams' for commitment in the Prairie Fire/Daniel Boone areas in 18
the event operations in NVN continued to be prohibited." ** 19

G. (TS) COMMUNICATIONS 20

Communications with Long term agent teams was through the high 21
frequency radio system [REDACTED] 22

[REDACTED] Short term teams (STRATA) communicated directly 23
with FOB. Danang using the SSB HF radio or via an airborne relay using 24
AW/PRC-25 radios. * 25

1. (TS) PROJECT BUGS. It was the responsibility of the Project 26
Bug organization to transmit all out going team messages as re- 27
quested by SOG, and in accordance with the signal plans developed 28
by SOG for each team. Bugs also monitored all radio frequencies 29
assigned to each team by its communications plan. The messages 30

* (TS) Historical Summary, Airborne Studies Group, "SOG Annual Historical
Summary" 5 Jan 69, p 115,116, (SACSA)

** (TS) ibid. p 82.

1.5(c)
3.4(b)(1)

from the teams were then relayed to SOG communications 1
and from there to OP-36 Airborne Studies Group. These messages 2
were encrypted and were forwarded to the translation center 3
for decryption and translation-into English. 4

2. (S) RESUPPLY COMMUNICATIONS. Proper communications 5
with active agent teams, just prior to resupply, was particularly 6
important. A message of intent to resupply was sent to the team 7
to the mission being conducted.
10 days prior / During the day that resupply was expected to be 8
accomplished, a special broadcast (contact) schedule was for- 9
warded to Bugs. The teams received this schedule seven days 10
prior to resupply. On the day of resupply the appropriate 11
team was notified from one to three hours prior that the air- 12
craft was on its way or had to cancel. ** 13

* (S) Report, MACJ3, "AD HOC Evaluation Group Report," 14 Feb 1968,
Timberwork (c) p 4 (SACSA).

** (S) SOP, Airborne Studies Group, 25 March 1969, p 18 (SACSA).

PART III. OPERATIONS (U)

1

A. (TS) INTRODUCTION

2

Airborne operations are presented in the paragraphs that follow by the various programs that were controlled by the Airborne Section of SOG: Long-Term Agent Teams, STRATA Teams, Singleton Agents, and Diversionary Operations. This presentation will be chronological in a sense because until 1968 the Long-Term Agent Program represented essentially the entire airborne effort. (The first two STRATA teams were infiltrated in late 1967.)

3

4

5

6

7

8

9

B. (TS) BACKGROUND

10

The Airborne Section of SOG took over in January 1964 from the CAS organization,

11

12

13

14

15

16

17

1.5(e)
3.4(b)(1)

[REDACTED]

[REDACTED]

1.5(e)
3.4(b)(1)

[REDACTED]

18

C. (TS) GENERAL CONDUCT OF OPERATIONS

19

Initially, agent teams were infiltrated by parachute from the C-123 fixed aircraft or put ashore by boat.

20

21

1.5(e)
3.4(b)(1)

As covered in Part I, in September of 1965,

22

23

24

25

26

27

28

29

[REDACTED] teams

were infiltrated by: (a) direct parachute insertion from C-123 or C-130 (later) aircraft originating from Tan Son Nhut or Camp Long Thanh, or; (b)

[REDACTED]

(1) History, MACSOG, "Annex A to MACV Command History, 1964," p. I-9. (SACSA).

FIGURE CB-5
 SUMMARY OF TEAM HISTORIES, 1961-1964 (U)^{b/}

Team Name	Original Date	Number Dropped	Resupplied/Reinforced Date	Number	Men Lost and Reason ^{b/}	Agents	Actions Completed
[REDACTED]							
ATTILA	25 Apr 64	6	None	None	Six teams captured (800).	0	None
DOONE	29 Jul 64	9	None	None	Nine DRV announced capture and trial of seven men. One DIA on drop, one unknown (missing).	0	None
BUFFALO	19 Jun 64	10	None	None	Ten DRV announced capture & trial (800).	0	None
LOUIS	19 May 64	6	None	None	Six DRV announced capture & trial (800).	0	None
SCORPION	17 Jun 64	6	None	None	Six DRV announced capture & trial (800).	0	None
TOTAL						38 (800)	

1.5(c)
 3.4(b)(1)

1.5(c)
 3.4(b)(1)

^{b/} Source: (TS) History, MACSO, "Annex A to MACV Command History, 1964 (U)," p. II-15.

[REDACTED]

C-b-36a

1.5(c)
 3.4(b)(1)

Communications with agent teams was via Project BUGS [REDACTED] 1
[REDACTED] The capability to 2
exfiltrate teams through the Fulton Recovery System (see Air 3
Operations, Annex C, [REDACTED] for description) or by helicopter was 4
available, but there was not to be a successful exfiltration by 5
either of these methods of a long-term agent team.* 6

Step
3.4(b)(1)

1. (S) Mission. Teams were given physical destruction missions 7
(earlier teams), intelligence collection missions, and/or psychological 8
missions (later). The PSYOP material provided in resupply packets 9
consisted of leaflets and posters with the Sacred Sword Patriots' 10
League (SSPL) theme for distribution along trails and other places 11
where the populace might pick it up. Also included were bogus 12
packets of material purportedly from Red China which gave Mao's 13
thoughts about establishing Red Guard movements and other activi- 14
ties counter to the interests of North Vietnam.* 15

2. (S) Exfiltration. It was not intended that long-term agent 16
teams would remain in NVN for an indefinite period. Of the many 17
attempts to exfiltrate, none were successful. Team NANSEN was 18
exfiltrated by helicopter from a friendly area in Laos; however, 19
the team had not reached its assigned area in NVN and was not 20
considered a reporting team. Exfiltration by either helicopter or 21
Fulton Recovery System was available, but fear or lack of desire 22
for exfiltration or operational difficulties thwarted every effort.** 23

3. (S) Resupply. Aerial resupply missions were flown in 24
the earlier years by C-123/C-130 aircraft. With the build up of 25
enemy air defenses in NVN, an increasing number of resupply missions 26
were flown by F4 and A1 aircraft. (In 1966, C-123/C-130s were 27
scheduled for twice as many resupply missions as F-4/A1 aircraft. 28
The situation was reversed the next year, 1967.) When the long-term 29
teams were infiltrated, they had an initial supply of provisions. 30
The ideal resupply schedule was based on four drops per year, with 31
cost of supplying one agent in NVN for one year estimated at \$2,500.** 32

* (S) Report, MACJ3, "Ad Hoc Evaluation Group Report," 14 Feb 1968,
TIMBERWORK(C), p. 5-6. (SACSA)
** (S) Ibid., P. 12.

D. (1) LONG-TERM AGENT TEAM OPERATIONS

1. (1) Operations - 1964. SOG inherited [redacted] agents assigned to [redacted] teams: [redacted]

One new team, EAGLE, was successfully infiltrated during the year. There were 13 successful resupply missions flown out of 55 scheduled; 21 were aborted. (See Figure CB-6.)

[redacted]

(Figure B-5 includes a summary of team histories through 1964.)

a. Team Locations - 1964. Figure CB-7 shows the locations of the six in-place teams and infiltration points of the five captured teams during 1964.

b. New Developments - 1964

"In the spring of 1964, methods of improving drop techniques were reviewed so that an all-weather, all-month schedule could be maintained. Poor weather conditions and light of moon requirements were holding the in-place teams' program at an unproductive level.

(1) "Ideas Considered

(a) " Drop Through Clouds from High Altitude

1. "A beacon signal with less vertical diffusion is needed. The aircraft must know when it is exactly over the beacon. An Air Force test item, RED CHIEF, was reported to have promise.

2. "A two-beacon technique for pin-pointing the drop point was considered. One beacon on the DZ; the other on the flank. With different frequencies, one leads the aircraft on line over the DZ and the other indicates drop points from the flank.

3. "The use of drogue parachutes with padded bundles in high velocity drops were considered. With dopler radar, the ballistics of such bundles can be computed accurately enough to determine the impact point. This information then could be relayed to the team if they did not see the bundles fall.

(b) "Low-Level High-Speed Drops. MARK-4 resupply bombs were considered. They can be dropped from a subsonic aircraft at low altitude. The bomb is lowered to the ground by parachute.

* (1) History, MACSOG, "Annex A to MACV Command History, 1969," p. II-D-1, (SACSA).

1.5(e)
3.4(b)(1)

1.5(e)
3.4(b)(1)

1
2
3
4
5
6
7
8
9
10
11

FIGURE CB-6 (S)

SUMMARY OF AIR OPERATIONS IN SUPPORT
OF AIRBORNE OPERATIONS - 1964 (U)

Month 64	Operations Scheduled	Aborted -- (Turned back or did not take off)	Unsuccessful (Once over DZ)	Successful (Dropped)
Jan	4	1	0	0
Feb	5	2	3	0
Mar	4	1	0	0
Apr	4	1	0	0
May	4	4	0	2
Jun	4	2	0	3
Jul	5	0	1	4
Aug	5	1	0	0
Sep	5	2	0	0
Oct	6	5 ^{a/}	0	1
Nov	5	2	0	1
Dec	4	0	0	2
Total	55	21	4	13

^{a/} Operations cancelled by higher authority.

SOURCE: (TS) History, MACSOG, "Annex A to MACV Command History,
1964 (U)," p II-D-1

EO96-00403

MACSOG DOCUMENTATION STUDY
APPENDIX B TO APPENDIX C
Page C-b-40

DENIED IN ENTIRETY

Under Executive Order 12958
Sections 1.5(c) and 3.4(b) (1)

C-b-40

(c) "Low-Frequency Homers. Two AN/MRV-13 low-frequency homers (navigational aids) were made available."*

(2) Continuing Problem. The problem of resupply during poor weather and non-light-of-the-moon nights was never solved. Consequently, the resupply of teams was unreliable and unsatisfactory as many resupply / were delayed for months at a time in their resupply schedule.

2. (1) Operations, 1965-1967

a. 1965. "The Airborne Operations Section commenced operations in 1965 with six teams totaling 59 agents in-place in North Vietnam. The primary mission of all these teams originally was to conduct limited ambushes, target destruction, and psychological and harassing operations against designated targets. In October, the emphasis on target destruction decreased and the gathering of intelligence through the expansion of local contacts and the utilization of roadwatch teams increased. To this end, two specially trained road/river watch teams were infiltrated, and four teams were reinforced by road/river watch trained personnel. Only one element (Sub-Team REMUS ALFA) of a team (REMUS) was lost during the year, and its three members are listed as missing and presumed captured. An additional six agents were killed and three more died of natural causes. Numerous targets were damaged or destroyed and a large number of intelligence reports were received and forwarded to the Intelligence Section for evaluation. The operational teams were resupplied/reinforced nineteen times during the year."**

b. 1966. "The Airborne Operations Section began operations in 1966 with nine in-place teams, representing a total of 78 agents. The mission of the Airborne Operations Section in conjunction with Strategic Technical Service (STS) counterpart personnel, was to recruit, train, equip, and infiltrate agent teams into NVN, and subsequently to resupply, reinforce, and exfiltrate these agent teams- for the purpose of collecting intelligence, conducting sabotage and psychological operations, and [redacted]

[redacted] The CINCPAC-stated principal objectives for OPLAN-34A ground operations in NVN were to develop low-key tribal potential in North Vietnam and also to develop and operational area astride each major line of communication for the purpose of:

- (1) Rail/road/river watch
- (2) Target acquisition for air strikes
- (3) Wire tap of NVN landlines -
- (4) Development of civilian intelligence networks in every operational area
- (5) Conducting limited harassment and interdiction operations
- (6) Rendering assistance [redacted]

* (TS) Ibid., P. II-G-2.

** (TS) History, MACSOG, "Annex N to MACV Command History, 1965," p. II-A-5.

"Three new operational teams, KERN, SAMSON, and HECTOR, were infiltrated on 5 March, 5 October, and 22 June. Operational teams were resupplied 28 times during the year. Team KERN (7), TOURBILLON ALFA (4) and HECTOR BRAVO (11) were lost during the year. 11 agents were killed in action and three more died of wounds. Eight agents were wounded in action, one died of non-battle injuries, and five died of disease."* (Figures B-8, B-9 and B-10 give a tabular summary of 1966 agent team operations.)

c. 1967. "The Airborne Operations Section began operations in 1967 with eleven in-place teams, representing a total of 76 agents. CINCPAC directed in April that TIMBERWORK (C) guerrilla teams be infiltrated in NVN for the conduct of the following operations: intelligence collection, target acquisition, development and support of civilian intelligence and [redacted] early warning, selective harassment, psychological operations and [redacted]"

(1) "To accomplish this mission the Airborne Operations Section in conjunction with Strategic Technical Directorate (STD) personnel recruited, trained, equipped and infiltrated agent teams into NVN, and subsequently resupplied, reinforced and attempted to exfiltrate these agent teams. Four new operational teams, HADLEY, NANSEN, RED DRAGON and VOI, were infiltrated on 26 January, 22 April, 21 September and 18 October, respectively. Two PLOWMAN (C) detainees, GOLDFISH and PERGOLA, were infiltrated as singleton agents on 13 September. Two STRATA teams, 111 and 112, were infiltrated on 24 September and 22 October, respectively.

(2) "Operational teams were resupplied 28 times during the year.

(3) "Teams, SAMSON, HECTOR, BELL and VERSE were lost during the year. Seven agents were killed in action and one more died of wounds. One agent was wounded in action, five died of non-battle injuries, and three died of disease."**

(4) Figures B-11, B-12 and B-13 give a tabular summary of 1967 agent team operations. 1 2

d. Exfiltration Efforts. The period from 1965-1967 was notable for several unsuccessful team exfiltration efforts. A summary of three of these efforts, Teams REMUS A, TOURBILLON A and BELL are outlined below: 3 4 5 6

* (1) History, MACSOG, "Airborne Operations, MACV 1966 Command History," p. 61.
** (2) History, MACSOG, "Annex G to MACV Command History, 1967," p. G-III-4-1.

FIGURE B-8 (7)

LOCATION OF IN-PLACE TEAMS DURING 1966 (U)

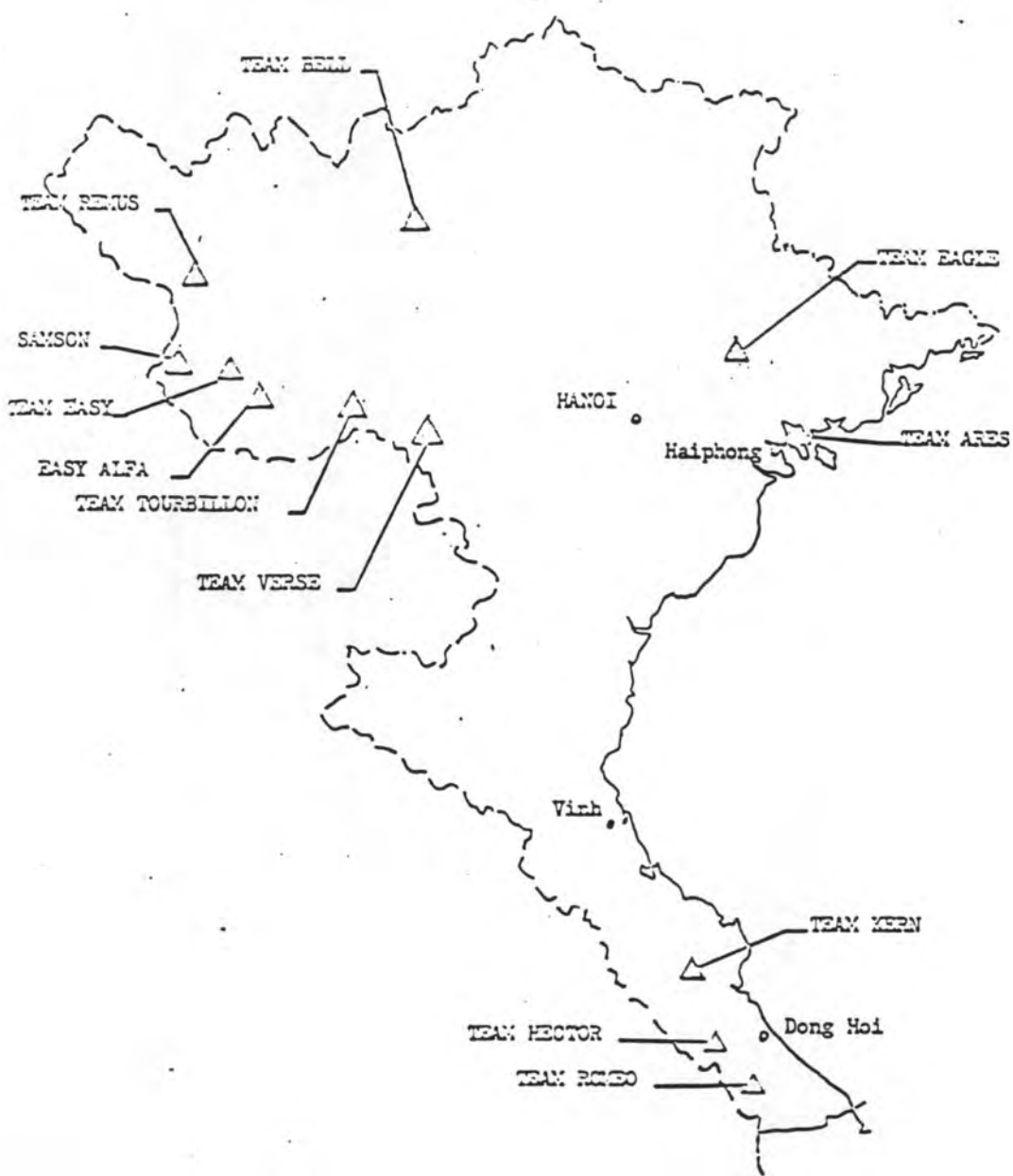

FIGURE B-9 (IS)

RECAPITULATION OF OPLAN-34 TEAMS RESUPPLIED DURING 1966 (U)

Month	ARES	EAGLE	BELL	REMUS	SAMSON	EASY	EASY ALFA	TOURBILLON	VERSE	KERN	HECTOR	ROMEO
Jan			X									
Feb	X	X					¹ X _a /					
Mar				X				X	3X			² X
Apr	⁴ X		X			X						X
May												
Jun									X _a /	X	X	
Jul				X				X	X			
Aug		X	⁵ X							X		
Sep			X			X					X _a /	
Oct						⁶ X _a /					7X	
Nov				X	X		X				X _b /	
Dec								X				

a/ Denotes two resupply missions.

b/ Denotes diversionary resupply mission.

NOTE: 1 thru 7 denotes teams were unable to locate resupply bundles.

FIGURE B-10 (S)

RECAPITULATION OF OPLAN-34 IN-PLACE AGENT LOSSES DURING 1966 (U)

Month	Killed in Action	Wounded in Action	Missing in Action	Died of Wounds	Died of Injuries	Died of Disease
Jan						
Feb						
Mar	1	1	1 ^{a/}		1	
Apr				1		
May	5	1				1
Jun						2
Jul	3	2		2		
Aug						
Sep	2	3				
Oct		1	1			
Nov			4			1
Dec			18			1
TOTAL	11	8	23	3	1	5

a/ Agent rejoined team in May.

AGENT STRENGTH OF OPLAN-34 IN-PLACE TEAMS DURING 1966

<u>Jan</u>	<u>Feb</u>	<u>Mar</u>	<u>Apr</u>	<u>May</u>	<u>Jun</u>	<u>Jul</u>	<u>Aug</u>	<u>Sep</u>	<u>Oct</u>	<u>Nov</u>	<u>Dec</u>
78	78	86	84	78	91	86	86	95	101	96	79

FIGURE B-11 (U)
LOCATION OF IN-PLACE TEAMS DURING 1967 (U)

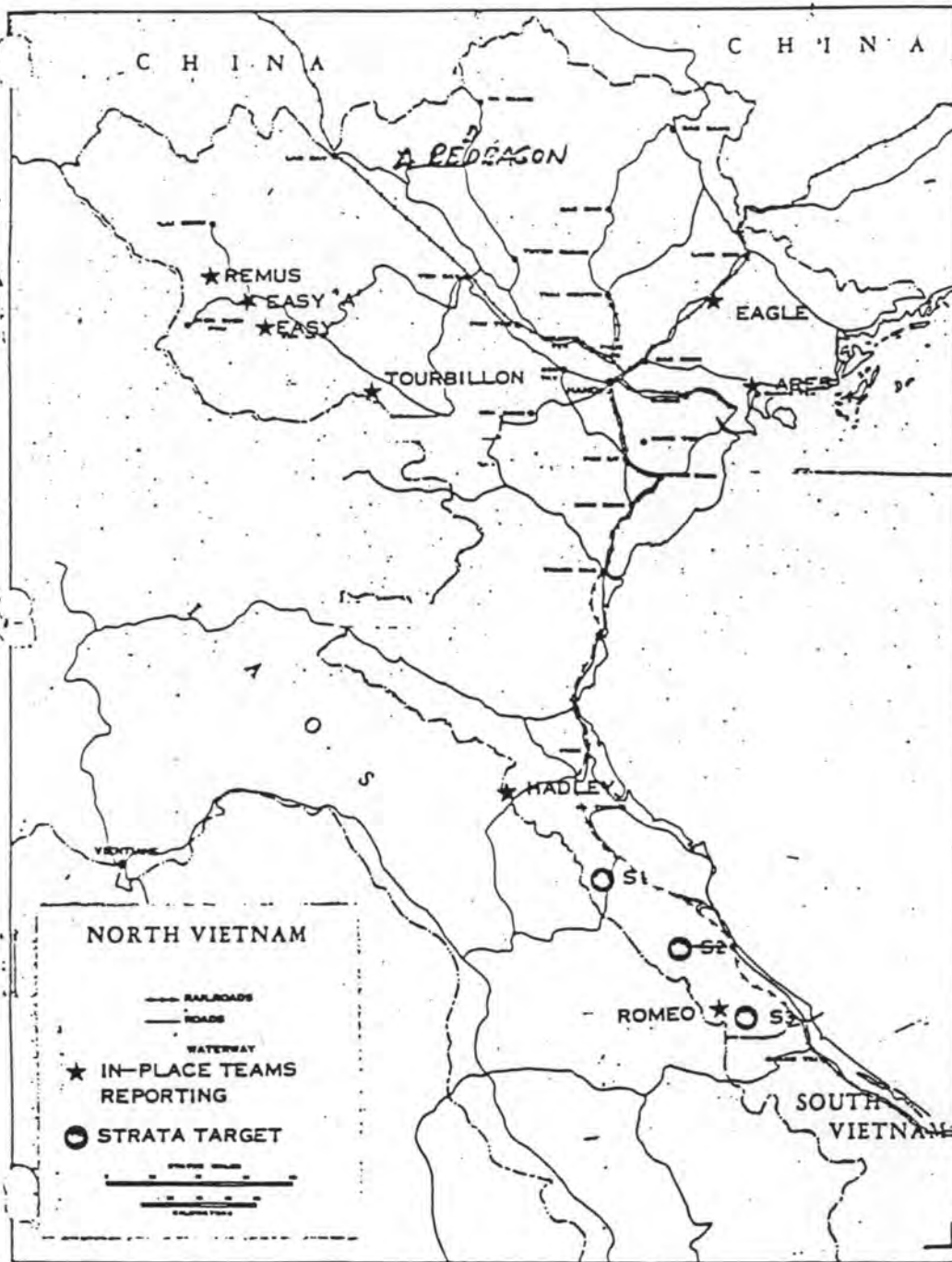

FIGURE B-12 (U)

RECAPITULATION OF OPLAN-34 TEAMS RESUPPLIED DURING 1967 (U)

Team	Jan	Feb	Mar	Apr	May	Jun	Jul	Aug	Sep	Oct	Nov	Dec
ARES	-----	-----	-----	-----	x	-----	-----	-----	-----	-----	-----	-----
EAGLE	-----	-----	-----	x	x	-----	-----	-----	-----	-----	-----	x
REMUS	x	---	x	-----	-----	-----	-----	x	-----	-----	-----	-----
NANSEN	-----	-----	-----	x	-----	-----	-----	-----	-----	-----	-----	-----
EASY	x	---	x	-----	-----	-----	-----	x	x	---	x	---
EASY ALFA	x	---	x	-----	-----	-----	-----	-----	-----	-----	-----	-----
HADLEY	-----	-----	x	-----	-----	-----	-----	-----	-----	x	-----	-----
TOURBILLON	-----	-----	-----	-----	-----	-----	-----	-----	x	x	-----	-----
VERSE	x	-----	-----	x	-----	-----	-----	-----	-----	-----	-----	-----
RED DRAGON	-----	-----	-----	-----	-----	-----	-----	-----	x	x	-----	-----
HECTOR	x	-----	-----	-----	-----	-----	-----	-----	-----	-----	-----	-----
ROMEO	---	x	x	-----	-----	-----	-----	x	---	x	-----	-----

FIGURE B-13 (TS)

RECAPITULATION OF OPLAN-34 IN-PLACE AGENT LOSSES DURING 1967 (U)

	Jan	Feb	Mar	Apr	May	Jun	Jul	Aug	Sep	Oct	Nov	Dec
Killed in Action	-	-	-	-	6	-	-	-	-	-	1	-
Wounded in Action	-	-	-	1	-	-	-	-	-	-	-	-
Missing in Action	-	8	-	-	-	12	4	-	9	-	1	-
Died of Wounds	-	-	-	1	-	-	-	-	-	-	-	-
Died of Injuries	1	-	1	1	-	-	1	-	1	-	-	-
Died of Disease	-	-	1	-	-	-	-	-	2	-	-	-
TOTAL	1	8	2	3	6	12	5	-	12	-	2	-

(1) REMUS A. This was the first attempt to exfiltrate an element of an OPLAN 34 agent team. A five-man element of Team REMUS was instructed to move overland approximately 40 kilometers into Laos [REDACTED]

[REDACTED] The last radio transmission was on 21 August 1965: "Caching radio, heading for Vientiane," It was assumed that the team was captured by the Pathet Lao in Laos.*

(2) TOURBILLON A. In May 1966** COMUSMACV proposed a concept to exfil-rate three agents from Team TOURBILLON who had been infiltrated in 1962. Following exfiltration, the three agents would provide: intelligence; a source of experience for the critique of agent training; field experienced instructions; and tangible evidence to trainees that exfiltration of in-place agents was possible.***The exfiltration plan, approved by the Joint Chiefs of Staff, State Department, and Department of Defense, was:

"Team TOURBILLON 'A' is directed to conduct a bogus mission and establish a DZ to receive a resupply during a designated period. After the team is in place, a photo reconnaissance will be conducted to confirm the exact location and to determine if there are any indications that the team is controlled by NVN. On the first suitable day after the photos have been analyzed, a three man Vietnamese snatch team is [REDACTED]

[REDACTED] escorted by USAF armed aircraft, transports the snatch team to TOURBILLON 'A' LZ/DZ, located on the NVN/Lao border to arrive at the bogus resupply time. TOURBILLON 'A' is picked up and returned via the same route to SVN."****

TOURBILLON A began movement toward the exfiltration point on 27 August 1966. The exfiltration was scheduled for 11 September and the team acknowledged preliminary instructions. However, no further contact was made with the team and the exfiltration had to be cancelled. TOURBILLON A was dropped from the agent rolls effective 30 November 1966.

* (TS) Memo, CJCS to DEPSECDEF, "OPLAN 34A Team Exfiltration," 20 July 1966. (SACSA)
** (TS) Msg, MACV, DTG 050051Z May 66.
*** (TS) History, MACSOG, "Annex M to MACV Command History - 1966," p. 59. (SACSA)
**** (TS) Memo, CJCS to SECDEF, "Oplan 34A-Team Exfiltration (TS)," 20 July 1966. (SACSA)

1.5fe)
3.4(b)(1)

(3) Team BELL. In November 1966, COMUSMACV forwarded a concept* to exfiltrate the five members of Team BELL by USAF HH-3 helicopter.

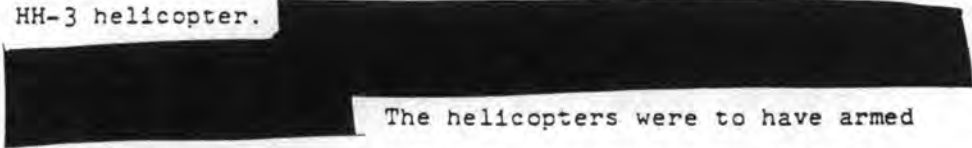

The helicopters were to have armed aircraft for cover. The attempt to execute the plan was made on 23 February 1967. The team was not at the LZ to meet the helicopter and later reported that while preparing to mark the LZ, they had been alerted to the chattering of monkeys and feared that people were approaching. Subsequent exfiltration attempts were delayed because of weather and enemy activity in the LZ. The last contact with the team was on 19 March 1967, and on 2 July 1967 Hanoi radio announced the capture of the team and gave the team leaders name for confirmation.

3. Operations, 1968-69. Airborne operations were influenced significantly by the restrictions on operations imposed in April and November 1968, and by the security evaluation in June which judged that all in-place teams were probably under NVN control.

a. In January 1968, there were eight in-place teams operational in NVN. Since that time, two teams, EASY and REMUS, were compromised by NVN and three teams, HADLEY, TOURBILLON and ROMEO were stopped transmitting and / carried as missing in action (MIA). The three remaining teams on 1 July 1969, ARES, EAGLE and RED DRAGON were considered as probably compromised.**

b. During March and April 1968, US case officers assigned to long-term agent teams conducted a security survey of their respective teams. To further assist in this evaluation, Chief MACSOG requested a counterintelligence survey be conducted by a representative from J-2 MACV staff and CAS, Saigon. The findings of

* Msg, COMUSMACV, DTG 060139Z Nov 66. (SACSA)

** (b) Historical Summary, Airborne Studies Group, "SOG Annual Historical Summary," 5 Jan 69, p.3. (SACSA)

this survey*, in June 1968, indicated that all teams were under NVN control. Subsequent plans called for dropping all in-place teams at the earliest feasible time; in most cases by using the tactic of ordering the team to move toward an exfiltration LZ. Experience had shown that when a compromised team was ordered to move, it soon was surfaced by NVN or ended radio contact.**

c. In January 1968, there were a total of 48 agents on eight in-place teams; in June 1969, there were nine agents in the three teams remaining. Seven aerial resupplies were made to teams during the above period. (See Figure B-14 for team locations.)

d. Resupply and Exfiltration. Although the restrictions of April prohibited air operations above 20°N latitude, it was considered essential by MACV to request clearance to resupply teams RED DRAGON and REMUS and to exfiltrate four members of Team EASY by helicopter from a LZ in Laos. Even though the teams were already suspect by the United States as compromised, the counterpart Vietnamese Strategic Technical Directorate (STD) personnel did not share this feeling. It was considered by MACV that if the teams believed secure by the STD were not supported, there would be an adverse effect on the entire unconventional warfare (UW) effort.***

(1) Clearance was granted by CINCPAC in April.****

However, Team REMUS transmitted its last message in April and was terminated. CINCPAC suspended# all resupply operations in May before Team RED DRAGON was resupplied. The bombing halt of 1 November ended all resupply plans for RED DRAGON.

(2) Clearance for the exfiltration of four members of Team EASY was received the same month, April 1968, as the final message from the team, 26 April 1968. On 7 August, a NVN / newspaper announced the capture of a "12 man spy-ranger team" that was Team EASY.##

* (TS) Report, CAS/J2USMACV, "Security Status of MACSOG Long-Term Agent Teams in NVN," 7 July 1968. (SACSA)

** (TS) Historical Summary, Airborne Studies Group, "SOG Annual Historical Summary," 5 January 1969, p.3. (SACSA)

*** (TS) Msg, MACV, DTG 240505Z Jul 68. (SACSA)

**** (TS) Msg, CINCPAC, DTG 130210Z Apr 68. (SACSA)

(TS) Msg, CINCPAC, DTG 222205Z May 68. (SACSA)

(TS) Historical Summary, Airborne Studies Group, "SOG Annual Historical Summary," 5 Jan 69, p.30.

FIGURE R-14 (TS)
LONG-TERM AGENT TEAM LOCATIONS (U)

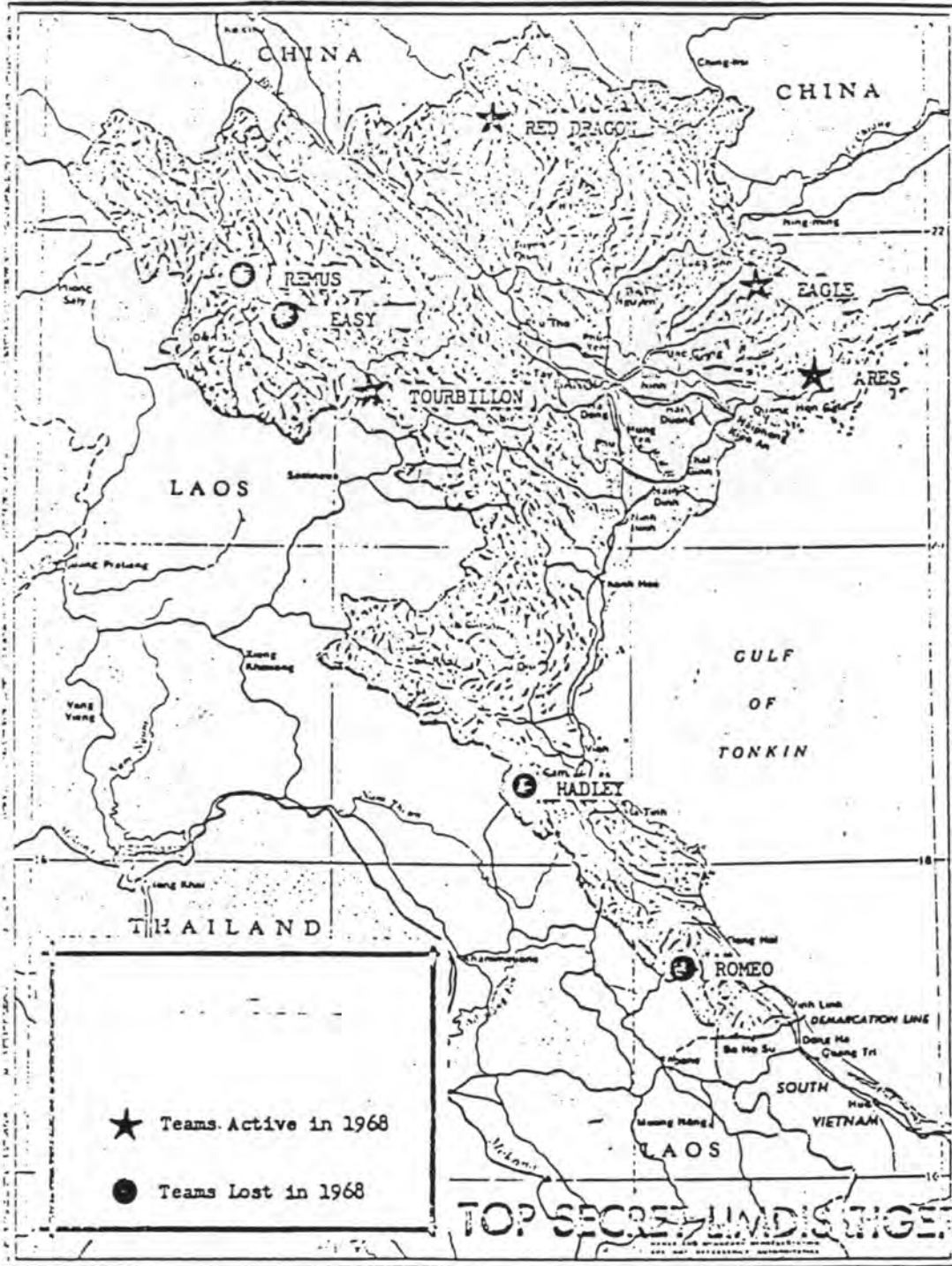

4. (S) Long-Term Agent Team Chronology

a. ARES



1
2
3
4
5
6
7
8
9
10
11
12
13
14
15
16
17
18
19
20
21
22
23
24
25
26
27
28
29
30
31
32
33
34
35

1.5(e)
3.4(b)(1)

beginning
(2) Operations. Continual analysis of ARES/in 1966 indicated that he was under hostile control. Since November 1968, he exhibited indications that the opposition was becoming impatient with the operation. ARES hinted several times that he was having difficulty with radio communications and Central (MACSOG/STD control headquarters) was asked to find another means of communication. ARES was informed in December 1967 that Central wanted to resupply him and he was instructed to find a suitable drop zone (DZ). ARES, however, immediately began to expound on the difficulties of finding and using DZs in the area and again pleaded with Central to find a way to resupply him by other means. It appeared that ARES was attempting to get Central to expose additional assets. With this in mind, a diversionary operation was implemented in June 1968. The object of this operation was to cause the security forces of Haiphong to expend their time and energies in useless pursuits and to implant the idea that Central has agents operating in the city of Haiphong. In June 1969, ARES was instructed to propose an exfiltration plan in international waters.*

* (S) History, MACSOG, "Annex F to MACV 1968 Command History," p. III-4-1. (SACSA)

C-b-52

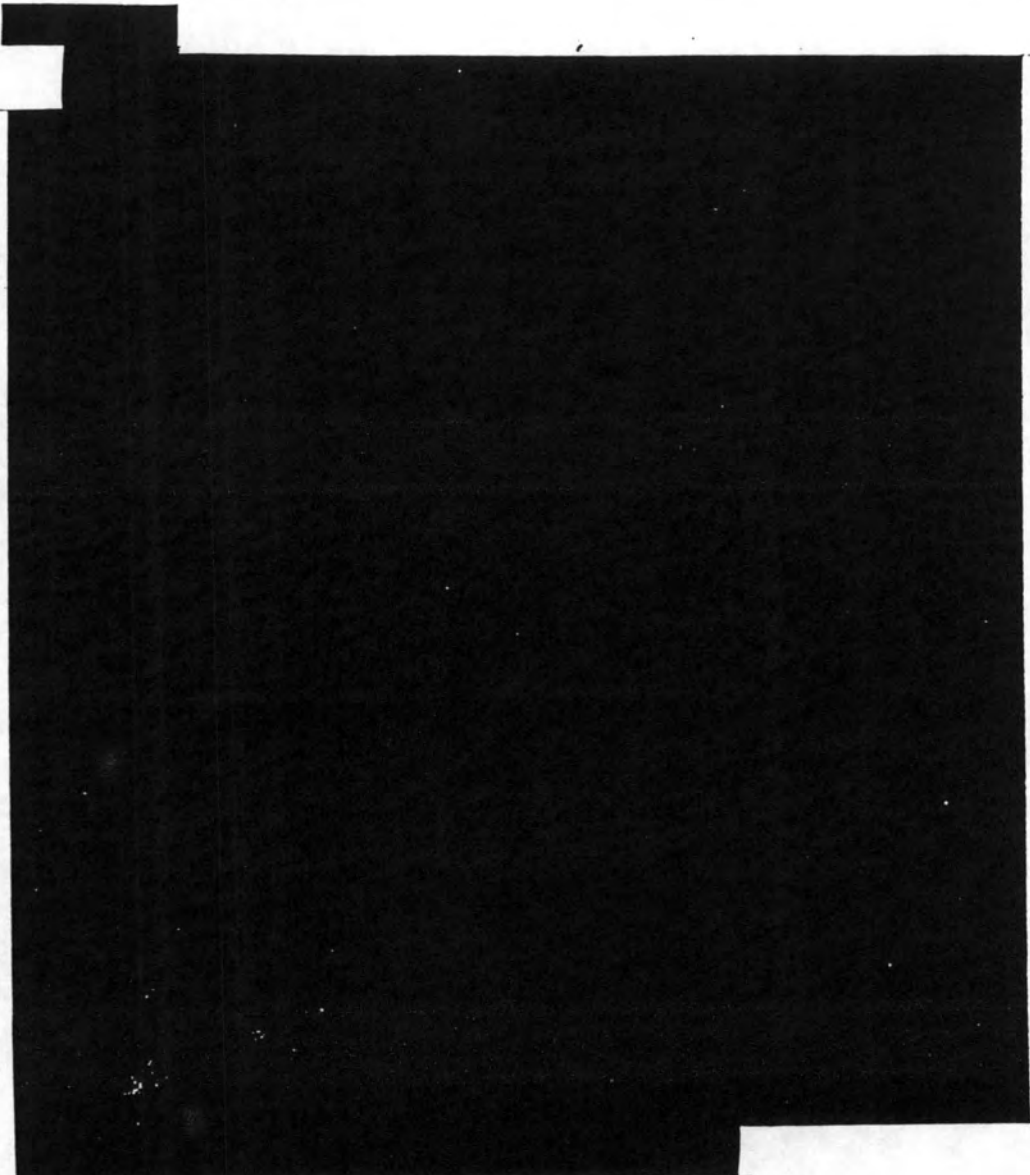

1
2
3
4
5
6
7
8
9
10
11
12
13
14
15
16
17
18
19
20
21
22
23
24
25
26
27
28
29
30
31

1.5(e)
3.4(b)(1)

c. TOURBILLON

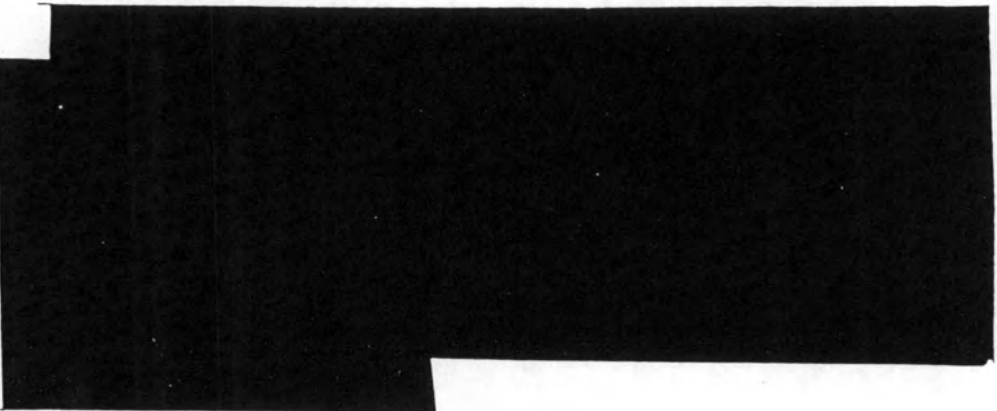

1.5(e)
3.4(b)(1)

* (A) Ibid.

(2) Operations. TOURBILLON first came under suspicion of being under hostile control in January 1967 when a reinforcement radio operator, infiltrated on 24 December 1966, transmitted messages containing duress signals. After further case officer analysis and a CAS security analysis of all in-place TIMBERWORK(C) teams, it was concluded that the team came under hostile control prior to December 1966,

 The team's activities in 1968 have essentially confirmed its controlled status. No significant intelligence information was reported and the team moved almost continually in an attempt to evade the enemy. Contact was maintained throughout the year in order to utilize the team in a diversionary effort.* The team was last heard from in December 1968, and was dropped from the active rolls in June 1969.

d. BELL





The entire year, 1965, was spent in unsuccessful attempts to resupply the team. The team moved several times during the year to new safe areas. Two agents died in December from lack of medicine and supplies.

1.5(e)
3.4(b)(1)

1.5(e)
3.4(b)(1)

1.5(e)
3.4(b)(1)

* (S) Ibid., p. F-III-4-C-1.

Little useful intelligence was received. The team was finally
 resupplied in April 1966 and was instructed to cross the
 Red River [REDACTED] On 28 May, the team
 attempted to cross the Red River in rubber boats, was inter-
 cepted by NVN militia, and retreated, suffering two KIA and
 lost equipment. In August, 4A resupply containers were
 dropped, but team was unable to locate them. On
 14 October 1966, another team member died. At the end of
 1966, ^{the} team was tasked to establish a rail/river watch at
 site vicinity VK 4935. In January 1967, CINCPAC approved
 a plan to exfiltrate team BELL. Abortive attempts were made
 in February and March to exfiltrate BELL. Bad weather and
 the fear of compromise of the LZ were primary obstacles.
 The team was last heard from on 19 March and was dropped
 from the active rolls on 3 July 1967.*

e. EASY



By 1967-1968, the mission had been reduced to
 intelligence collection by observation and exploitation of a
 locally recruited net of subsources.

(2) Operations. Analysis of Team EASY's files prior to
 June 1968 indicated the team was probably not under hostile
 control. The team was reinforced four times with a total

* (S) History, MACSOG, 1964-1967 MACV Command Histories.

1.5(e)
3.4(b)(1)

of 23 men. As of January 1968, five of the original eight
 members and seven of the 23 reinforcement members survived.
 EASY came under suspicion in March 1968, and in July 1968
 was determined by a joint MACV J-2 CAS security review to
 be possibly under hostile control. After being alerted
 that one seriously ill member and three other members were
 to be exfiltrated, the team went off the air and was last
 heard ^{from on} 26 April 1968. Subsequently, on 7 August 1968, a
 NVN newspaper reported that in late April (year not stated),
 a 12-man team of SVN rangers had been captured in Son La
 Province and the team leader was identified as the EASY
 team leader.*

f. "ATTILA. Team consisted of six Vietnamese that para-
 chuted on 25 April 1964 into tree drop area at WF 325575.
 Team mission was to sabotage bridges on Route 8 and conduct
 psychological operations in that area. One radio contact
 received 9 May 1964 indicated the team dropped in wrong loca-
 tion close to a populated area. No further contact since
 9 May. On 11 August 1964, Radio Hanoi broadcast that a team
 which had dropped on 26 April had been captured and sentenced
 by the DRV military court to eight years imprisonment. This
 was ATTILA."**

g. "LOTUS. Team consisted of six men who were dropped at
 WG 125587 on 19 May 1964. The team mission was to sabotage
 bridges on Route 1. Radio Hanoi reported sentencing of spy
 group who jumped the same day as LOTUS. No radio contact
 was ever made."**

h. "BUFFALO. The team consisted of a 10-man sabotage,
 psychological operations, and intelligence group that was
 dropped 19 June 1964 at WE 741886. The team was to work
 along Route 12. On 24 October 1964, Radio Hanoi announced
 the sentences of eight members of the BUFFALO group. No
 radio contact was ever made with the team."**

1. EAGLE 13

(1) Background. Team EAGLE was originally composed of six
 members, all natives of Bac Giang Province, NVN. The team
 was infiltrated back into the province on 27 June 1964, with
 the mission of conducting sabotage operations on NVN Routes
 1 and 4, Mac Nam Quan rail line, and the Mai Pha air base.
 The team has recruited two subsources to date, who were the

* (T) History, MACSOG, "Annex F to MACV 1968 Command History,"
 p. F-III-4-C-1. (SACSA)
 ** (S) History, MACSOG, "Annex A to MACV Command History 1964,"
 p. II-Q-1. (SACSA)

primary sources of information provided in 1968. The information received, however, has been of little or no value. In recent months, the team has been primarily tasked with roadwatch assignments. EAGLE'S mission in 1967 was essentially changed to collection of intelligence information, although it was tasked with a sabotage mission in March 1968. The mission was not completed. The team now consists of three members of the six originally infiltrated.

(2) Operations. Continual analysis of EAGLE since 1967 indicates that the team is under hostile control. Therefore, in 1968, plans were developed to move the team south from its safe area for possible exfiltration. EAGLE was notified to move south, but was not informed of the reason for it. After a brief period of delaying, the team finally reported starting its movement in November.* The team was instructed to send an exfiltration plan but none was forthcoming. In the summer of 1969, team was moving back to original location. It was expected that the team would soon break contact and terminate.

j. "SCORPION. Team of seven men dropped on 17 June 1964 between VJ 701971 and VJ 679977. The team mission was to sabotage the Lao Key rail line between Yen Bay and Trai Hut. On 27 July 1964, Radio Hanoi reported the team of six men had been captured shortly after their drop by alert local citizens. Dinh Man, the seventh man, was reported killed when he stubbornly resisted capture."**

k. "BOONE. Team consisted of nine men that were dropped at approximately VG 594086 on 29 July 1964. The team was never heard from."**

1. EASY (ALFA). Infiltrated in September/October 1965 to give instruction in roadwatch techniques to EASY. In November the team was contacted by the enemy and one agent was killed. Team set up roadwatch on Routes 44A and 69. In May 1966, two agents were killed during a skirmish with the enemy.

* (S) History, MACSOG, "Annex F to MACV 1968 Command History," p. F-III-4-C-1. (SACSA)
 ** (TS) History, MACSOG, "Annex A to MACV Command History 1964," p. II-Q-1. (SACSA)

Team submitted roadwatch reports and was successfully 1
resupplied for remainder of 1966. In July 1967, EASY (ALFA) 2
arrived at the cache site of EASY and the two teams were 3
joined.* 4

m. ROMEO 5

(1) "Background. Team ROMEO, originally composed of 10 ethnic NVN was infiltrated back into an area immediately north of the DMZ in November 1965. Its mission was to conduct area reconnaissance for collection of intelligence information; perform roadwatch mission; and conduct harassing and sabotage activities on order. Primary target in the team's area was NVN Route 103, which was believed to be a major route for infiltration of men and supplies to the south. In October 1966, the ROMEO radio operator sent the words, 'ROMEO already captured,' in the clear. Since that time, mission accomplishment has been regarded as insignificant. The team had not furnished any reportable information during 1967 and 1968.

(2) "General. In 1968, the team's activity was generally limited to location of DZs and searching for survival food. ROMEO had been plagued with communications problems since its infiltration and the trouble persisted in 1968. Many messages were received with undecipherable groups and numerous delays in message traffic were experienced due to necessity for retransmissions. Contact with ROMEO was finally lost 5 August 1968 while the team was reportedly on a reconnaissance mission. It is believed the decision to terminate the team was influenced by two events: a diversionary caching operation which was successfully completed in early June, followed by a reconnaissance mission into a closely forested area where little or no intelligence information could be gathered. Team ROMEO was composed of four remaining members when it was declared MIA on 4 November 1968."**

n. VERSE. Team was infiltrated by parachute in November 6
1965 to train Team TOURBILLON in roadwarch techniques and then 7
to detach and set up its own roadwatch on Route 68. Roadwatch 8
was established by VERSE in January 1966. Location of team 9
near an antiaircraft site made resupply impossible except by 10
high-performance aircraft. Resupply^{was}/finally accomplished in 11
mid-1966. Team reported on Route 68 and Route 6 during year. 12
Exfiltration for team was planned for mid-1967; however, ^{the}team 13
was captured by the enemy between 3 and 27 July 1967.*** 14

* (S) History, MACV Command Histories 1965-67", (SACSA).
** (16) History, MACSOG, "Annex F to MACV 1968 Command History," p. F-III-4-C-1. (SACSA).
*** (16) History, MACV Command Histories 1965-67. (SACSA)

o. KERN. Infiltrated on 5 March 1966 by paratroop
 from ^aC-123. Mission was to conduct roadwatch in Mu Gia Pass
 area. Difficulty experienced in locating team from air
 during first months after infiltration. Five members of
 the seven-man team were ill in June 1966. Location by
 infra-red photography was effected in June 1966. Resupply
 in August. Team last heard from on 5 September 1966.*

p. HECTOR. Infiltrated 15 men on 22 June 1966 by CH-3C
 helicopter. Contact with team on 9 August. Report that
 four members were ill. In September 1966 team reinforced
 with 11 agents (HECTOR BRAVO), resupplied, encountered
 enemy and were forced to flee. Exfiltration plans for team were
 drawn up in November. HECTOR BRAVO was dropped from rolls after
 no contact since 23 September. Exfiltration effort in
 December unsuccessful. Team had not been heard from since
 15 March 1967, and was dropped from the active rolls effective
 26 June 1967.*

q. SAMSON. Eight agents with wire tap equipment infil-
 trated on 5 October 1966. Resupplied and established road-
 watch in November. Team last heard from on 2 December 1966.*

r. HADLEY

(1) Background. NVN Route 8 is an improved motorable
 road connecting Route 15 to Laos Routes 81, 12 and 121.
 These routes are considered major troop and supply infil-
 tration routes to the south. In addition, the Ngan Pho
 River, running west to east in the same area is a principal
 water supply route. A black team installed in this area
 could provide valuable information on flow of infiltration
 traffic. Team HADLEY's mission was to conduct roadwatches,
 emplace a roadwatch device, identify potential air strike
 targets, and, on order, to conduct harassment and sabotage
 operations.

* (S) History, MACV Command Histories 1965-67.

(2) Operations. Team HADLEY was infiltrated on 25 January 1967 by helicopter in Laos for overland movement into NVN. The team was placed on the wrong LZ due to pilot error and in its initial radio contact, made on 17 February 1967, reported that it had been compromised upon landing and was still trying to evade the enemy. It is believed that all communications equipment, except for one RS-1 radio and some Panasonic radios, were destroyed or lost during this period. Communications with the team throughout 1968 were generally good, with almost immediate responses to messages. Originally, an 11-man team, HADLEY, is now composed of seven members. Two members died in 1967 and another two in 1968. Current view on the security survey completed in June 1967 concluded the team had been captured soon after infiltration. HADLEY was, therefore, used primarily in a diversionary capacity in 1968.* The team was instructed to exfiltrate into Laos but was last heard from in February 1968. Was listed as MIA on 24 May 1969.

s. NANSEN. Seventeen agents infiltrated by USAF helicopters on 22 April 1967



t. RED DRAGON

(1) Background. The Red River Valley from the NVN/China border town of Lao Kay to Hanoi is a major LOC with many rail, road and water transshipment points from about 21°N.

* (S) History, MACSOG, "Annex F to MACV 1968 Command History," p. F-III-4-C-1. (SACSA)
 ** (S) History, MACSOG, "Annex G to MACV 1967 Command History," p. G-III-4-15. (SACSA)

A black team located in Lao Kay and Yen Bai Provinces would be in an excellent position to conduct sabotage and intelligence missions. Planning for such an operation began in early 1966 and the concept was approved by CINCPAC in May 1967.

(2) General. Team RED DRAGON was widely dispersed on its infiltration drop on 21 September 1967. Difficulty in assembling and the loss of one radio caused a 32-day delay in the team establishing its first radio contact. Radio communications with the team in 1968, as in 1967, were generally poor due to atmospheric conditions and frequent retransmissions were necessary. RED DRAGON's security status was a matter of question since its initial radio contact, and the question continued to plague both US and VN case officers throughout the year. While US personnel were convinced the team was under NVN control, the VN counterpart case officer felt otherwise. This difference in opinion had a marked effect on handling of the team until June, when a MACV J2/CAS security review indicated the team was under hostile control. Maintenance of RED DRAGON was further complicated by difficulties in resupply. The team was resupplied on 18 March 1968 by FAC aircraft, but the limited bombing halt declared on 1 April 1968, prevented any further resupply of the team. RED DRAGON, therefore, spent much of its time in 1968 searching for survival food and was largely unproductive. Although it was conceded the team was not useful, nor could it be used in support of any diversionary operation, contact was maintained throughout 1968 because of the VN counterparts' belief the team was secure.* Team was last heard from in June 1969 and is expected to break contact.

* (2) History, MACSOG, "Annex F to MACV 1968 Command History," F-III-4-C-1. (SACSA)

u. VOI. Four agents infiltrated on 18 October 1967.
No contact ever established after infiltration.*

v. Teams 915 and 919. The teams had been recruited in the spring and summer of 1968, but had not completed training at the time of the 1 November bombing halt. Team 915 commenced training at Camp Long Thanh in October and 919 in January 1969. The teams were recruited in SVN from persons who had migrated in the 1950s from NVN to the Danang and Nha Trang areas. Team 915 first mission on 12 January was a 10-day infiltration 20 kilometer into Cambodia for a roadwatch mission. The team completed a longer, 20 day, mission in February, also into Cambodia. Both missions were judged successful. Team 919 performed its first mission, also into Cambodia, on 9 June 1969. The team was attacked immediately after infiltration and had to exfiltrate with a loss of three men. These two teams have remained under the operational control of OP-36, Airborne Studies Group.

5. (S) Summary. Figure B-15 is an abbreviated chronology of all recorded long-term agent team infiltrations from 1961 through the final insertion in 1967.

E. (S) STRATA TEAM OPERATIONS

1. (S) General Conduct of Operations

a. Authority. By the original authority message for STRATA operations** CINCPAC was authorized to approve STRATA missions with the Joint Chiefs of Staff an information addressee on all messages. CINCPAC approved 15 STRATA targets in a series of messages transmitted from May of 1967 until July 1968. (See STRATA "Authority" file in SACSA.) Mission numbers were assigned by CINCPAC and authority was given to strike an approved target on more than one mission.

* (S) History, MACSOG, "Annex G to MACV 1967 Command History," p. G-III-4-22. (SACSA)

** (T) Msg, CINCPAC, 120052Z Apr 67. (SACSA)

Chronology of Long-Term Agent Team
Inserts

Team Date How Pers -- Remarks

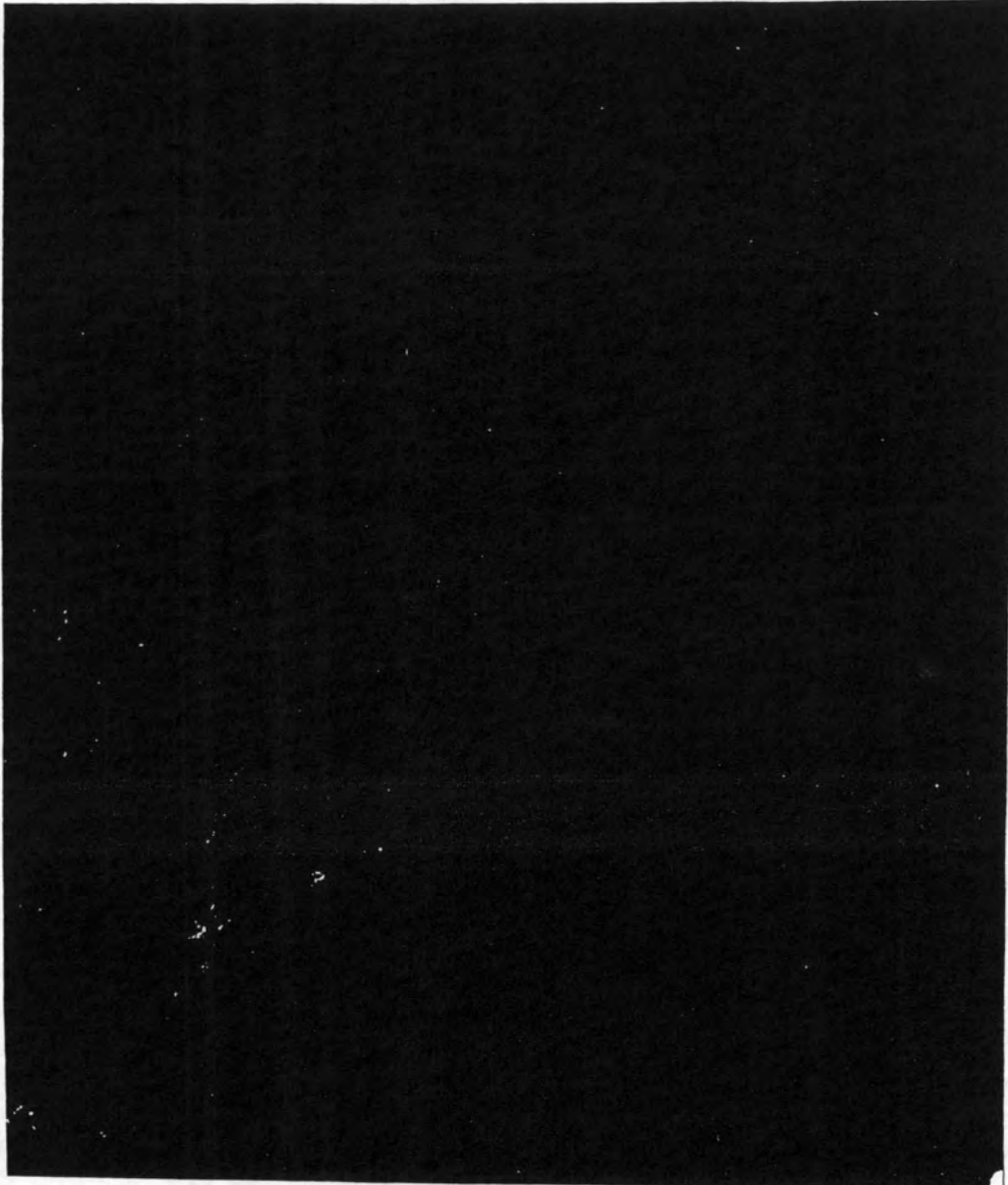

1.5(e)
3.4(b)(1)

FIGURE B-15 (S) (Cont'd)



1.5(e)
3.4(b)(1)

- 27. [no name] 23 Apr 64 Air 3 Reinf for Tm REMUS
- 28. ATTILA 25 Apr 64 Air 6 Captured soon after landing, Action 55?
- 29. LOTUS 19 May 64 Air 6 Captured, tried by NVN
- 30. COOTS 27 May 64 Air 7 Reinf for Tm TOURBILLON
- 31. SCORPION 17 Jun 64 Air 7 Captured, tried by NVN
- 32. BUFFALO 19 Jun 64 Air 10 Captured, tried by NVN
- 33. EAGLE 28 Jun 64 Air 6 Jun 68 analysis: Tm believed under NVN control. 3 men still in Tm. Inst'd to move south, began move Nov 68. Still in radio contact 69.
- 34. PISCES 18 Jul 64 Air 6 Reinf for Tm EASY
- 35. PERSEUS 24 Jul 64 Air 7 Reinf for Tm TOURBILLON
- 36. BOONE 29 Jul 64 Air 9 Captured, tried by NVN
- 37. ALTER 22 Oct 64 Air 4 Reinf for Tm REMUS
- 38. GRECO 14 Nov 64 Air 7 Reinf for Tm BELL
(CENTAUR Team) (28) Tm destroyed 10Dec64 in C-123 crash on Monkey Mountain, Da Nang. See pg II-J-1, 64 History
- REMUS ALPHA May 65 5 Part of Tm REMUS inst'd to exfil to Laos. Last contact 21Aug65 vic TJ 785367; "Caching radio, heading for Vientiane (Laos)."
- 39. HORSE May 65 Air 5 Reinf for Tm EASY
- 40. DOG/GECKO 17 Sep 65 Air 9 Reinf for Tm EASY. Later redesign: Tm (EASY ALPHA) EASY ALPHA (30Oct65). Tm rejoined Tm EASY in Jul 67.

FIGURE B-15 (Cont'd),

41. VERSE	7 Nov 65	Air	8	Infil to Tm TOURBILLON; 2 men killed as result of drop. Tm inst'd Tm TOURBILLON in roadwatch techniques. 21 Dec 65, Tm TOURBILLON gave 3 men to Tm VERSE; VERSE detached. 27Jul67, Hanoi Radio announced capture.
42. ROMEO	19 Nov 65	Helo	10	Oct 66 received msg in clear text: "ROMEO ALREADY CAPTURED." Last radio contact 5Aug68; declared MIA 4Nov68.
43. KERN	5 Mar 66	Air	9	1 man killed on drop, last radio contact 5Sep66, dropped 7Dec66.
44. HECTOR	22 Jun 66	Helo	15	Reinf 11 men (Tm HECTOR BRAVO) 23 Sep 66. HECTOR & HECTOR BRAVO never linked up. BRAVO dropped 28Dec66. Last contact w/HECTOR 15Mar67; dropped 26Jun67.
45. SAMSON	5 Oct 66	Helo	8	LZ in Laos. Last radio contact 2Dec66, dropped 1Mar67.
46. TOURBILLON BRAVO	24 Dec 66	Air	2	Reinf for TOURBILLON. Took in wiretap & electronic sensor devices.
47. HADLEY	26 Jan 67	Helo	11	LZ in Laos. Foot infil to NVN. Jun 68 analysis: Tm believed captured soon after landing. Used as diversion since Jun 67, told to exfil to Laos. Mar 69 Tm rept'd they were in Laos again & ready for pickup; could not locate.
48. NANSEN	22 Apr 67	Helo	17	LZ in Laos. Tm never reached NVN, enemy vic LZ, requested exfil. See pg G-III-4-15, 67 History.
49. [no name]	21 Aug 67	Air	2	Reinf for Tm REMUS
50. GOLDFISH	13 Sep 67	Sea	1	Infil by PLOWMAN(C) Mission 327. Agents had been recruited from detainees on PARADISE. Agents were to remain in-place 60-90 days & exfil by sea. Never contacted.
51. RED DRAGON	21 Sep 67	Air	7	Widely dispersed on infil. US Case Off believed Tm under NVN control, VN Case Off believed Tm OK as result of Jun 68 analysis. Radio contact continues in Apr 69.
52. VOI	18 Oct 67	Air	4	No contact ever estab after infil.

b. Mission. It was originally intended* that STRATA teams would be well indoctrinated in the SSPL and leave leaflets and posters along the trails in their operational areas. However, in August 1968, SOG directed that STRATA teams no longer be tasked with multiple missions on the same operation, e.g., roadwatch, [REDACTED] and SSPL distribution. Subsequently, STRATA teams were charged with only one mission per infiltration, principally: roadwatch, reconnaissance, or [REDACTED]. Distribution of SSPL material was halted as a secondary mission.**

c. Typical Mission. Once a STRATA team had been assigned a mission objective and a designated area of operations, the selected team was alerted and placed in an isolation area. Concurrent with alerting the team, SOG requested diplomatic clearance [REDACTED] scheduled C-130 for flight of the team from Camp Long Thanh or Danang [REDACTED] which was the helicopter launch area, and requested helicopter support from the [REDACTED] if the team was to be infiltrated by helicopter. The C-130 landed at [REDACTED] and ground coordination was effected with helicopter crews [REDACTED]. During coordination, the STRATA team changed into NVN uniforms. The helicopters were moved adjacent to the C-130, and the team transferred. The helicopter flew a selected route to the objective area. An air CAP of fighter-bomber aircraft was airborne on an on-call basis to support the helicopters and team in the event of emergency. The C-130 orbited over Laos and acted as an airborne command post until the team insertion was declared a success by the case officer. Case officer personnel returned to Forward Operating Base (FOB) Danang and maintained a radio listening watch for approximately 48 hours. Normal radio communication was then turned over to FOB personnel who maintained contact with the STRATA team while the team remained in the mission area.***

* [REDACTED] Report, MACJ3, "Ad Hoc Evaluation Group Report," 14 Feb 1968, TIMBERWORK(C), p.6. (SACSA)
** [REDACTED] Historical Summary, Airborne Studies Group, "SOG Annual Historical Summary," 5 Jan 69, p.11. (SACSA)
*** [REDACTED] Report, MACJ3, "Ad Hoc Evaluation Group Report," 14 Feb 1968, TIMBERWORK(C), p.11. (SACSA)

d. Organizational Change. The bombing halt of 1 November 1968 restricted any further operations in North Vietnam. The final two STRATA teams to be deployed in the North were exfiltrated on 23 October. STRATA assets, including the Monkey Mountain FOB, Studies were turned over to OP-35 (Ground / Group) for employment in the PRAIRIE FIRE and DANIEL BOONE/SALEM HOUSE areas of operation. (The operations of the STRATA teams from November until July 1969 will be covered in the Appendices on Laos and Cambodia.) An evaluation by SOG of STRATA operations under OP-35 resulted in the teams being returned to the control of OP-36 (Airborne Studies Group) on 1 July 1969. The principal factors prompting the return was the deterioration of training and morale resulting from reduced individual attention devoted to the teams under the OP-35 arrangement.

2. (S) Mission Narratives - 1967-1968. Only two teams were inserted in 1967; one of which was exfiltrated. From January 1968 until the bombing pause of 1 November, 24 STRATA teams were infiltrated into NVN.

"Twenty teams were successfully exfiltrated with all members, three teams exfiltrated minus missing members, and Team 120 has been missing in its entirety since 17 May. There were twelve meeting engagements with enemy personnel [15 STRATA agents were lost] . . . Nine intelligence reports were forwarded to higher headquarters based upon information gathered by STRATA teams."*

Narratives of all STRATA missions conducted prior to the bombing halt of 1 November 1968 are included below**:

a. "STRATA III, composed of 7 VN agents was infiltrated by CH-3 helicopter into NVN vicinity of XE 0744 on 240715Z Sep 67. Team was to move to roadwatch sites along route 101, vicinity of XE 1254 and report real-time intelligence in STRATA Target Area 5. Infiltration was accomplished without incident. No enemy contact but because of difficult terrain, illness of two team members, and lack of water, team was emergency exfiltrated by CH-3 helicopter vicinity of XE 1048 on 281045Z Sep 67."

b. " STRATA 112, composed of 10 VN agents parachute infiltrated into NVN vicinity WE 787854 at 221920Z Oct 67 on STRATA Target 1. Enroute to roadwatch site overlooking junction

* (1) History, MACSOG, "Annex F to MACV 1968 Command History," F-III-4. (SACSA)

** (16) Memo, CINCPAC Staff, "STRATA Teams", undated.

of route 15 and 101, team made unexpected contact with enemy and requested exfiltration. Four exfiltration attempts by CH-3 helicopters were unsuccessful. Team last heard from 7 Nov 67. Subsequent recon missions failed to locate team and on 11 Jan 68 STRATA 112 was dropped from active agent rolls.

c. " STRATA III, composed of 8 VN agents, infiltrated by CH-3 helicopter into NVN vicinity XE 452009 at 171547H Mar 68, on STRATA Target 7. Mission of team was to conduct roadwatch along Route 196. Infiltration was without incident; team moved off the LZ and established cache site off the LZ and established a position at XE 454018 at 171800H. At 180700H team moved out toward roadwatch site and at 181345H contacted two squads local militia. After a twenty minute firefight in which three enemy were killed or wounded the team withdrew. Prior to withdrawal team heard three explosions believed to be M-14 anti-personnel mines previously emplaced by team. Team then established an overnight 'safe area' and at 190700H established radio contact with FOB Danang. During day of 19 March team observed other enemy militia activity but had no further contact with enemy. Team heard three more explosions, believed to be other M-14 mines, from the direction of firefight area. At 200700H team contacted 02 FAC aircraft. Team made two additional contacts with FAC and on 221050H was visually located by aircraft observer. Team was extracted by CH-3 at 231345H, vicinity XE 417016. Team found no evidence to determine whether or not significant infiltration traffic is passing through the local militia force of less than company size. No regular NVA activity noted.

d. "STRATA 113, composed of 8 VN agents, infiltrated, vicinity XE 436125, by CH-3 helicopter on 310835Z Mar 68, on STRATA Target 7A. Team established radio contact with FOB, Danang and reported its position on 010755Z Apr 68. No enemy contact reported. Team reported on 030610Z Apr 68 that they had arrived at Base Camp location, vicinity XE 439105. No enemy contact. On 4 April, team conducted reconnaissance in Base Camp area. Due to lack of enemy contact, team mission extended for five (5) days in order to provide ample time for thorough reconnaissance of Route 1961. On 5 April, team reported completion of reconnaissance of Route 1961, no information furnished (at this time) on results of reconnaissance. Team exfiltrated from vicinity XE 417121 at 070805Z Apr 68.

e. " The FAC control of the helicopter insertion of one STRATA team (114) and the extraction of another STRATA team (113) on the same mission is proving to be a sound method for control of helicopters flying through hostile areas and for locating LZ's.

f. "STRATA 114, composed of 8 VN agents, infiltrated on STRATA Target 7B, vicinity XD 484985 at 070747Z April 1968. Team contacted FOB, Danang by voice and CW at 071045Z April and on 080710Z April and reported its position vicinity XD 474989. Team moving toward Route 196, vicinity XD 4599. Team contacted FOB, Danang by radio (CW) on 090015Z April, no enemy contact. At 090830Z April, team contacted six enemy armed with AK 47 rifles. No friendly casualties, enemy casualties unknown. Team instructed to move south to Route 196, vicinity XD 4497. 110130Z April, team contacted FOB. Team located vicinity XD 466992. FOB directed team to move south to XD 4696. CW radio contacts at 120100Z and 120335Z April. Team located XD 458792. Team instructed to cross Route 196, vicinity XD 4496, to take pictures, emplace mines, and leave leaflets. On 13 April team emplaced M-1 mines, left SSPL leaflets and flag vicinity XD 459983 (suspected enemy checkpoint). One hour later team heard explosions from the direction of the emplaced mines. Team exfiltrated by CH-3 from

vicinity XD 432982 at 150920Z April. During exfiltration hoists with jungle penetrators were used for pickup. No friendly casualties and unknown enemy casualties. Excellent PRC 74 voice and CW communications established and maintained throughout the operation. Failure of enemy to pursue team after contact on 9 April indicates that enemy troops are local militia or have specific location, such as way station, to guard.

g. "STRATA 122, composed of 4 VN agents, infiltrated on STRATA Target 2, vicinity XE 363215 at 150523Z May 1968. Radio contact established; team leader reported all members well and no problems encountered on infiltration. On 16 May, team reported its location as XE 354215; stated that upon completion of the infiltration team moved on azimuth of 265 degrees through rugged terrain, observed many trails with footprints and traces with direction of travel toward 200 degrees. Team located vicinity XE 354215 and reported hearing the firing of heavy weapons (at 152300Z May) from an area west of its position (XE 354215). Team plans to remain at XE 354215 and conduct reconnaissance of area. On 17 May, team located XE 352214 and still encountering high rocky terrain. One team member reported ill at 161230Z May and as a result, team will remain temporarily at XE 352214. Team observed jet aircraft strike to its West at 160920Z May and another airstrike to the North. No secondary explosions. Negative enemy contact. On 180140Z May, team reported its location vicinity XE 356214. One team member reported ill; FOB provided medical treatment advise via radio. Team will move to LZ, vicinity XE 337216 for planned extraction on 21 May. On 19 May, team visually sighted at XE 356218 by STRATA FAC observer. Team scheduled for extraction 21 May. On 20 May, team still located vicinity XE 356218. Team extracted vicinity XE 3521 at 220520Z May. Debriefing at FOB, Danang underway.

" Since one member of the team became ill (later illness was diagnosed as severe kidney infection the team determined they could not continue mission (rugged terrain coupled with team member's illness) on 17 May and team requested exfiltration on 22 May. From 17 May until extraction on 22 May the team performed only those activities connected with their security, survival, and exfiltration. Extraction was accomplished by CH-3, using hoist and jungle penetrator.

"No enemy contact, no friendly casualties.

"Since the team did not reach its objective (Route 137) no roadwatch information was provided. Some usable information was reported concerning terrain, flora, and fauna which possibly could be useful survival/evasion/escape information for future operations in the area.

h. "STRATA 111, composed of 7 VN agents, infiltrated on STRATA Target 7C, vicinity XE 4404 at 140544Z May 68. On 15 May team reported its location as XE440036. Negative contact with enemy. On 16 May 68, team reported its location as XE438105, no contact with enemy, and team moving on azimuth of 145 degrees. On 17 May, team located at XE 449098. Team reported hearing rifle fire at 161015Z May at 1,000 meters and 90 degrees from XE 442008 and dogs barking and rifle fire approximately 1,000 meters away on an azimuth of 10 degrees from XE 442008. Negative enemy contact. Team located at XD 452095 at radio contact 180245Z May. Team proceeding on heading of 145 degrees toward Route 196. As of 20 May, team still in vicinity XD 452095, will proceed to roadwatch site. 21 May, radio contact continues; team moving on azimuth of 145 degrees toward roadwatch site. On 23 May contact by air to ground voice

and FOB to team by CW radio. As of 240305Z May team located at XD491936; will move to roadwatch site at XD 444977. On 250010Z May, team 'rogered' for team traffic and continued to move toward roadwatch site. Last contact 270145Z May; extraction planned for 28 May. Team extracted from NVN, vicinity XD518926 at 290445Z May 68. Debriefing underway at FOB, Danang on 30 May 68. Debriefing completed 31 May 1968.

1. "STRATA 120, composed of 6 VN agents, infiltrated on STRATA Target 7D, vicinity XE 5206 at 140533Z May 1968. Radio contact with FOB established at 150900Z May. Team directed to provide situation and location report. On 16 May team reported location as XE 527080 and no enemy contact. Team located at XE 536064 at radio contact 170910Z May and reported experiencing difficulty in movement because of rocky terrain. Team moving east toward target area overlooking SONG LONG DAI river and LANG MO village. Team last heard from on 170910Z May, vicinity XE 536064. Team supposedly split into three two man reconnaissance elements to conduct river watch. Communications should be re-established by 21 May; if not, planned overflight will be conducted 22 May, with observation aircraft using FM radio for air to ground contact. On 22 May negative contact with FOB Danang, ABCCC aircraft or O-2 observer, search continues on 22 May. No contact on 23 May; all emergency search and contact procedures now in effect. No contact on 24 May. Emergency contact procedures still in effect 25 and 26 May; negative contact. Team last reported 170910Z May. Emergency contact procedures included: Danang FOB single sideband, CW and voice radio broadcasts on scheduled and unscheduled basis; ABCCC aircraft trans-missions hourly; blind broadcasts over SSPL transmitter; O-2 and A-1 aircraft overflights using FM radio and search for visual signals. Team is presumed missing. O-2 aircraft overflights will continue to look for team on a periodic basis.

j. "STRATA 113, (8 VN) infiltrated vicinity XE 2631, on STRATA Target 2A, on 220424Z May 68. Mission is to conduct roadwatch on Route 137. Negative contact with FOB as of 240500Z May. As of 260030Z May negative contact with FOB. O-2 aircraft overflight scheduled for 26 May. Air to ground contact established 260530Z May via O-2 aircraft. Team located at XE280318; reports difficulty with PRC 74 radio. O-2 observation aircraft flight planned for 25 May; STRATA observer will transmit instructions to team via FM radio. Team contacted by O-2 observer aircraft 29 May, vicinity XE 282326. Resupply will be attempted 30 May. Resupply mission cancelled 30 & 31 May due to weather. Team last heard by O-2 observer aircraft 29 May, vicinity XE 282326. Team contacted by O-2 aircraft on FM radio at 020330Z June. Team reported Base camp located at XE 268325 and roadwatch site at XE 310326. On 2 June team received two (2) resupply bundles in free-fall drop from O-2 aircraft. Team reports negative enemy contact and all team members safe. Team scheduled for extraction 5 June. Team visually sighted by O-2 aircraft observer 040510Z Jun at extraction LZ vicinity XE 279335; scheduled for extraction 7 June. Team extracted from vicinity 279335 at 070328Z June 1968.

k. "STRATA 114 (7 VN) infiltrated vicinity XD 569869, on STRATA Target #13, at 060415Z Jun 68. Mission is roadwatch of Route 1036 (vicinity XD 638848). Contact with team as of 070715Z Jun. Team located at XD 596865 as of 090730Z JUN; negative enemy contact. On 10 JUN team located vicinity XD 628855; team reported hearing bombers and rifle fire 091050Z JUN vicinity XD 623876 and XD630733. Team reported 101030Z JUN vicinity XD 631865. At 100830Z JUN team reported hearing many bombs approximately 300 meters from their position between 100800Z - 100830Z JUN. A 'no bomb line'

coordinates XD 620840, XD 650840, XD 630870 and XD 620870 has been established in their area effective 110225Z JUN. Team reported many trucks in area moving south on 111500Z JUN. A new 'no bomb line' established XD 6286, XD 6283, and XD 6584, effective 120300Z JUN. At 121300Z JUN team reported (from vicinity XD 634835) a truck park/motor pool in area XD 637845. Team reported truck convoys (of 30 vehicles each) moving on road between 1330Z and 2100Z hours. Trucks appeared to be heavily loaded military trucks. Air strikes in area have not hit road. At 121315Z JUN team reported that team leader, Ass't team leader, and one (1) radio operator had not returned from reconnaissance. Team contacted FOB 140200Z JUN from vicinity XD 614555 and reported that the three missing team members apparently contacted enemy during morning hours of 12 JUN. Small arms fire and grenade explosions were heard at base camp by the other four team members. No contact with three (3) missing members. Team (-) located by STRATA observer in O-2 aircraft at XD 608868 on 140550Z JUN. Team moving west to extraction LZ. On 15 JUN team (-) contacted vicinity XD 613866 by aerial observer; team continuing to move to LZ, no enemy contact reported. Team (-) contacted FOB Danang at 160330Z and 160700Z and reported location as XD 597865. Team (-), four indigenous members extracted vicinity XD 597865 at 180818Z JUN.

l. "STRATA 115. (7 CAMB) infiltrated vicinity WE 629911, in STRATA Target Area #11, at 190535Z June. Mission is roadwatch trail activity vicinity WE 715900. Negative radio contact as of 210550Z June. Team visually sighted at 220530Z June at WE666906. Team contacted O-2 aircraft on FM radio and sent coded message to STRATA air observer. Team contacted by radio 24 June at WE700920; re-supply scheduled for 250900Z June. Resupplied 26 June. Enemy contact 27 June vic WE 711925. No friendly casualties; one enemy KIA and two WIA. Team position compromised; exfiltrated 290719Z June '68. The exfiltration CH-3 received three hits from small arms approximately 1 KM from LZ; no casualties.

m. "STRATA 111. (7 VN) infiltrated vicinity XD 557921, in STRATA Target Area 13A, at 200531Z June. Mission is roadwatch of Route 1036. At 210230Z June, team reported its location at XD 568912; negative enemy contact, team moving toward roadwatch position on Route 1036. Team visually located at XD 557921 when contacted 220030Z June; negative enemy contact. Team contacted by radio 240145Z June, location XD 629894; negative enemy contact. Enemy contact 24 June vic XD 642893; laid mines and withdrew. Mines exploded shortly after withdrawal. Team safe vic XD 598890. Team reported safe 27 June, moving toward resupply DZ vic XD 586894. Second enemy contact 300925Z June vic XD 572902. One friendly WIA, estimate 3 enemy WIA (possibly DIA). Exfiltrated 300711Z June '68 vic XD 568893. Circumstances surrounding the wounding of one team member and inconsistencies noticed during debriefing have lead to the confinement of the team members during investigation by a SVN security agency and their removal from the STRATA Program.

n. "STRATA 117 (7 CAMB) infiltrated into NVN vicinity XD 440932, on STRATA Target #7E at 270538Z June. Mission was to observe, report, and record amount and identity of all traffic utilizing Rte. 196. Radio contact was established with FOB Danang and at 290600Z team reported its location as XD 472948; no enemy contact. On 30 June team reported its location as XD 464955; no enemy contact. On 2 July, team established roadwatch site at XD 439780; nothing significant reported. On 3/4 July, from a roadwatch site at XD 389750, team reported 'no enemy traffic of any description observed'. Team actually patrolled road and saw no evidence of recent use.

On 5 July, team reported from vicinity XD 435002; no enemy contact. Team exfiltrated from vicinity XD 435002 at 060736Z July. Upon completion of debriefing it was decided that the portion of Rte. 196, designated as STRATA Target 7E, is no longer considered a lucrative target for STRATA operations.

o. "STRATA 118 (7 VN) infiltrated into NVN vicinity XE 297376 in STRATA Target #2B, at 070931Z JUL 68; no enemy contact. Mission: roadwatch on Rte 137. At 100230Z Jul, team contacted FOB Danang and reported no enemy contact. At 100615Z JUL, team reported to STRATA aerial observer that they had made contact and were pursued by enemy troops; reported all team members safe. Team emplaced M-14 mines in area and withdrew to vicinity XE 295370. Team directed to move to vicinity XE 284351 for extraction. At 110230Z JUL, team reported all members safe and located at XE 305370. On 12/13 JUL, team continued to evade enemy enroute to extraction site located vicinity XE 284351. Team extracted from vicinity XE 292366 at 140825Z JUL 68. Team did not accomplish its surveillance mission of Rte 137. Roadwatch mission against Rte 137 rescheduled for on or about 30 JUL 68.

p. "STRATA 94 (7 VN) infiltrated into NVN, vicinity XD 594824, on STRATA target #13B, at 130652Z JUL 68. Mission: roadwatch Rte 1036 (Bat Lak Road). 15 July radio contact established; team reported being pursued by enemy, no casualties. At 161040Z JUL, team reported its location as XD 612827. On 21 JUL, team reported that it had established base camp at XD 618825; three team members conducted reconnaissance for roadwatch site. Base camp team members reported hearing small arms and explosion from direction of three recon members. Last contact 210855Z JUL. On 23 JUL team reported that the three recon members rejoined remainder of team at base camp; no friendly casualties. Recon element reported (1) that it was unable to reach proposed roadwatch site because of enemy security in area; (2) identified two other enemy-used trails and (3) distributed SSPL materials and took photos of area in vicinity of Rte 136. Team located vicinity XD 614833 on 24 Jul. On 26 JUL team located vicinity XD 594823; extraction scheduled for 28 JUL. Team extracted from vicinity XD 594823 at 280742Z JUL 68. Team failed to accomplish primary mission of roadwatch on Rte 1036. Secondary mission of distribution of SSPL material accomplished. During debriefing, interrogation response variance among team members resulted in the credibility of the team becoming questionable. Further interrogation, evaluation and remedial training underway.

q. "STRATA 93 (7 VN) infiltrated into NVN, vicinity XE 202458, on STRATA target #4, at 150645Z JUL 68. Mission: roadwatch on Rte 101. Located vicinity XE 196467 at 151005Z JUL; reported terrain conditions difficult. At 160745Z team reported its location vicinity XE 198488; one team member sustained leg injury in fall from steep cliff. On 21 JUL, team moved to vicinity XE 194476; because of injured team member and rough terrain team scheduled for extraction on or about 23 JUL. On 17 JUL, team reported a water shortage and requested, thru STRATA aerial observer, directions to nearest water. Team was informed that water available at XE 193467. Team failed to locate water. On 18 and 20 Jul aerial resupply of water attempted; in both instances resupply unsuccessful as water containers were broken upon impact. Team then directed to move to extraction site vicinity XE 194476 and on 23 JUL, team extracted from vicinity XE 196473. Team 93 failed to accomplish assigned mission of roadwatch on Rte 101.

r. "STRATA 115 (7 VN) infiltrated into NVN, vicinity WE 739891 at 210530Z JUL 68, on STRATA Target #11A. Mission: conduct reconnaissance and roadwatch on unnumbered routes vicinity WE 710923. Team located at WE 727906 at 220817Z Jul; no enemy contact. Team located vicinity WE 729911 as of 240700Z Jul 68; no enemy contact. Team located vicinity WE 726912 on 25 Jul; no enemy contact. On 26 Jul, team located vicinity WE 722917; no enemy contact. Team located vicinity WE 714920 on 27 Jul; resupply scheduled for 1 Aug. Team visually sighted by STRATA aerial observer on 31 Jul in vicinity WE 691911; air to ground radio contact established. On 1 Aug, Al-G resupply aborted when team reported DZ insecure; team directed to move to vicinity WE 740890. Last reported location WE 691912 as of 1 Aug. On 4 Aug team reported location vicinity WE 715892; visual and radio contact established with FAC aircraft on 6 Aug 68. Extraction planned for 9 Aug. Last reported location was WE 745891 as of 8 Aug. Team believed to have had contact with enemy forces 7-9 Aug vicinity WE 738891. Aerial search for team underway 9 Aug. Adverse weather 9 thru 11 Aug affected visual search. Aerial observer believed he sighted team vicinity WE 740880 on 12 Aug; observer received beeper signal on URC 10 radio and observed panel atop a 60 ft. tree. Adverse weather in area on 12/13 Aug; extraction planned for 14 Aug. Three (3) team members extracted from vicinity WE 696825 at 140732Z Aug 68; search will be conducted for four (4) missing members.

"Highlights from debrief of team 115: Team observed movements of 15 enemy groups (20-30 men each) on 061030Z Aug; team was located WE 742890 and enemy troops were moving along stream bed from NE to SW. At 070330Z Aug, an enemy platoon moved into team base camp vicinity WE 742890. Ten minutes firefight resulted in one team member WIA and left behind. Three other missing team members last seen during firefight. Prior to evacuation surviving team members distributed SSPL material vicinity WE 711923. Team accomplished primary mission in locating terminus unnumbered four meter wide road (previously reported 8 Jul 68) at vicinity WE 711924. Secondary mission of locating truck park vicinity WE 728913 also accomplished (area was located but no evidence of personnel or vehicle activity). Additional mission of distribution SSPL material was also accomplished at WE 711923. E and E techniques used by the three survivors proved sound; E and E route provided sufficient food and water. From all indications the three missing team members are still evading; aerial search efforts will be continued.

s. "STRATA Team 119 (6 VN) infiltrated in NVN, vicinity XD 575921 at 290558Z Jul 68, on STRATA Target #13C. Mission: roadwatch on route 1036 from vicinity XD 660945. On 31 July, team located vicinity XD 604924; team reported hut and watch tower vicinity XD 595724, no enemy contact. As of 1 Aug, team located vicinity XD 614397; no enemy contact. Team located vicinity XD 627934 on 2 Aug; negative enemy contact. Team located vicinity XD 637937 as of 4 Aug; no enemy contact. On 6 Aug, team reported observing 3 anti-aircraft guns fired from vicinity XD 676944 and enemy security force in vicinity XD 680950; team located vicinity XD 666194. On 7 Aug team reported observing two cars/carts vicinity XD 586846. On 8 Aug team reported sound of estimated enemy platoon firing AK weapons and reported hearing the firing of two rounds of artillery. Team located vicinity XD 653945 on 9 Aug. Team moved toward extraction site vicinity XD 590920; extraction planned for 13 Aug. On 10 Aug, team reported enemy search party in area; extraction planned for 13 Aug. vicinity XD 590920. On 12 Aug, team located vicinity XD 602921. Team reported two members separated from the rest of team (cause unknown); because of adverse weather in area extraction scheduled for 14 Aug. Four (4) team members extracted from vicinity XD 584926 at 140908Z Aug 68; search will be conducted for two (2) missing members.

"Highlights from initial debrief surviving members of team 119: Team leader and scout departed on recon at 100060Z Aug from vicinity XD 62837. Team (-) heard Neo voices at 100700Z Aug in vicinity base camp; team (-) evaded, thus became separated from other two (recon party) members. While evading team observed new trails in area, two trucks vicinity XD 688934; two new roads suspected to be by-pass routes for Rte 1036, and observed many wood-cutters clearing area. Team emplaced M-14 mines vicinity XD 657944 and distributed SSPI material vicinity XD 659940. Team took photos throughout area in vicinity of XD 575924, XD 585919, XD 590923 and XD635935. Other pictures taken but film in possession of team leader who is MIA.

t. "STRATA Team 116 (7VN) infiltrated into NVN, vicinity XD 585845 at 050810Z Aug 68 on STRATA Target #13D. Mission: capture NVA prisoner and place M-14 mines on routes of military traffic. No radio contact on 6/7 Aug. Team located vicinity XD 625844 as of 8 Aug. On 10 Aug, team located vicinity XD 651837. Team located vicinity XD 634845 on 11 Aug. Extraction scheduled for 15 Aug; last radio contact 11 Aug 68. Team located XD 592327 on 15 Aug; extraction planned for 16 Aug. Team extracted for vicinity XD 592828 at 160709Z Aug 68.

"Team had no visual or physical enemy contacts. Prior to extraction team located and investigated deserted "settlement". Area contained several supply; personnel and commo bunkers, and several buildings. Settlement appeared to have been recently used; team booby-trapped commo bunkers with claymore mines. Team did not accomplish primary mission of capturing a prisoner nor were they able to observe Rte 1036. This was team 116's first mission; reporting on settlement area/camp site was thorough and complete to include photos and sketch.

u. "STRATA Team 118 (6 VN) infiltrated into NVN, vicinity XE 264313 at 060544Z Aug 68 on STRATA Target #2C. Mission: roadwatch on Route 137 from vicinity XE 330180. As of 8 Aug, team located vicinity XE 268306. On 11 Aug, team located vicinity XE 281307 and reported being chased by enemy. Team located vicinity XE 287307 as of 14 Aug. On 15 Aug team located XE 293304 and reported enemy (unknown size) in area. On 17 Aug team reported they had observed an estimated enemy Bn. moving NE to SW at XE 298304; team located vicinity XE 291301. Team visually sighted, at XE 263314 at 200700Z Aug by STRATA aerial observer; voice contact established at same time. Team extracted from vicinity XE 26414 at 210641Z Aug 68.

"Debriefing highlights: Team reported visual and/or physical contacts with enemy personnel on 15, 16, 17 and 18 Aug. On 15 Aug three team members on recon observed NVA soldiers fleeing from airstrikes vicinity XE 313321 to XE 296296; airstrikes lasted several hours with sorties of two jets striking approximately every twenty minutes. About 30 NVA soldiers (carrying four wounded) moved toward recon site on morning of 16 Aug; enemy dressed in black uniforms, armed with AK-47's, BAR's and mortars. Recon element was seen by enemy and then recon element withdrew.

"At 161130Z Aug the team members went out to observe Rte. 137; located an enemy base camp vicinity XE 297302. Four enemy soldiers approached team, fired on team and team withdrew from vicinity XE 293301. Enemy searched for team members throughout the night.

"On 18 Aug while three team members were taking photos vicinity XE 306313 a company of enemy appeared; team withdrew after short fire-fight (unknown number enemy casualties; no friendly casualties); team emplaced M-14 mines along route of withdrawal.

"During the period 172300Z - 180050Z Aug team observed body of troops (270 by count, more not counted) moving SW, vicinity XE 298294, on trail parallel to Rte. 137. Troops were dressed in black uniforms, carried machine guns, AK-47's, 50 cal MG, mortars, and larger unidentified weapons.

"Team was not able to observe Rte. 137; observed several usable trails paralleling Rte. 137. SSPL material was placed at XE 306313; photos taken throughout area; M-14 anti-personnel mines emplaced vicinity XE 306313 and XE 300310. Team reported that enemy voices heard spoke with South Vietnamese accents.

v. "STRATA Team 94 (7 VN) infiltrated into NVN, vicinity XD 568868 at 140915Z Aug 68 on STRATA Target #13E. Mission: Roadwatch Rte. 1036. Team located XD 563859 on 15 Aug. On 16 Aug team located XD 556862; reported contact with enemy platoon at XD 581781 on 140830Z Aug. Team extracted from vicinity XD 565860 at 180805Z Aug 68.

"Debriefing highlights: On 14 Aug, four (4) NVA soldiers armed with AK-47's entered team base camp; during a three minute verbal exchange NVA soldiers urged STRATA team personnel to surrender. Team opened fire and killed all four enemy personnel. Team then withdrew from base camp after receiving approximately 500 rounds of small arms fire from estimated enemy platoon. During withdrawal team emplaced thirteen (13) M-14 anti-personnel mines along withdrawal route; no SSPL material distributed.

w. "STRATA Team 93 (7 VN) infiltrated into NVN vicinity XE 247483, on STRATA Target #4A, at 310806Z AUG. Mission: Roadwatch Route 101. No radio contact on 1 SEP. On 2 SEP, team reported enemy activity vicinity XE 252495. On 3 SEP, team reported negative enemy contact; established roadwatch site vicinity XE 249512. At 061420Z SEP, team reported hearing artillery fire to North of roadwatch site; team was unable to contact ABCCC aircraft on 6 SEP. Team reported following information on 7 SEP; from roadwatch site at 249512. Team observed 16 covered transport trucks moving E to W at 031200Z SEP. Trucks moved approximately 30 KM PH and traveled ten minutes apart. Team further reported that one infantry squad patrols Route 101 each day. Team also reported one bomb strike on Rt. 101 near roadwatch site. On 8 SEP, team withdrew from roadwatch site due to enemy activity in area; no enemy contact. On 9 SEP, team reported observing two trucks moving E to W at 091240Z SEP; no enemy contact. Team located vicinity XE 238512 on 10 SEP; no enemy contact. On 11 SEP, team located vicinity XE 263517; reported enemy patrols in area, on contact with enemy. On 12 SEP, team located vicinity XE 268513; no enemy contact. Team extracted from vicinity XE 268513 at 140635Z SEP.

x. "STRATA Team 116 (8 VN) infiltrated into NVN vicinity XD 557921, on STRATA Target #13F, at 090655Z SEP. Mission: [redacted] On 14 SEP, first radio contact (voice to FOB); team reported location vicinity XD 595926, no enemy contact. Team established base camp at XD 557921; ambush site established nearby to attempt [redacted] No radio contact 15/16 SEP. On 17 SEP, team reported termination of ambush site; no enemy activity in area, and team now patrolling vicinity XD 589920 in effort to locate enemy and [redacted] No enemy contact or activity through 19 SEP. Extraction on 22 SEP cancelled due to adverse weather; team located and visually sighted at LZ site vicinity XD 557923 on 21 SEP. Team extracted from vicinity XD 557923 at 230710Z SEP. Mission of [redacted] not accomplished.

Prisoner capture

y. "STRATA Team 92 (8 VN) infiltrated into NVN vicinity WE 714777, at 150502Z SEP on STRATA Target #11B. Mission: area reconnaissance. No radio contact through 17 SEP. On 18 SEP, team reported successful insertion, establishment of cache site at WE 715799, slow movement because of difficult terrain, from vicinity WE 711798 (on 17 SEP) heard three rounds LMG fire and several artillery explosions approximately one mile east of their position. On 19 SEP, team reportedly on heavily used trail vicinity WE 712793. On 21 SEP, team reported having been pursued by enemy during night of 21 SEP. On 22 SEP, team reported its location at WE 724823 and reported two enemy companies using trail in area; further reported having emplaced M14 mines and heard subsequent explosions during night 21/22 SEP; no enemy contact. Team reported its location at WE 720860 as of 240030Z SEP. On 25 SEP team located WE 718860, reported negative enemy contact. Team located at WE 698883 on 26/27 SEP; no enemy contact. Team extracted from vicinity WE 713825 at 280517Z SEP.

NOTE: Subsequent to the 1 November 1968 stand-down STRATA assets were retrained/reoriented for operations in the PRAIRIE FIRE/SALEM HOUSE areas of operation. Operations commenced in the PP/SH AO's in December 1968.

3. (TS) Mission Summary. A summary of all STRATA operations* until the bombing halt can be seen in Figure B-16. 1 2

4. (TS) STRATA Targets. Fifteen STRATA targets were approved by CINCPAC. Figure B-17 identifies the targets and outlines MACSOG justification in each case.* 3 4 5

5. (TS) Target Locations. Figure B-18** is an abbreviated list of the 24 STRATA missions conducted in 1968. Figure B-19** is a chart showing the target area of each mission conducted. (The two missions conducted in 1967 and not included on the chart were directed at target areas 5 and 1, respectively.) 6 7 8 9 10

* (TS) Ibid.

** (TS) History, MACSOG, "Annex F to MACV 1968 Command History," p. F-III-4. (SACSA)

~~TOP SECRET~~

FIGURE B-16
SUMMARY OF STRATA TEAM OPERATIONS (U)

Target		Team		Date		Comments
Designation	Location	Designation	Strength	Infiltrated	Exfiltrated	
85	XE 1353	111	7	24 Sep 67	26 Sep 67	Emergency exfiltration due to lack of water and illness.
81	WE 8780	112	10	23 Oct 67		Night parachute infiltration. Team made unexpected contact with enemy. Last contact 7 Nov 67. Stricken from active rolls 10 Jan 68.
87	XE 452009	111	8	17 Mar 68	23 Mar 68	No significant activities.
87A	XE 436125	113	8	31 Mar 68	7 Apr 68	No significant activities.
87B	XD 484985	114	8	7 Apr 68	15 Apr 68	Enemy contact; no friendly casualties; enemy unknown. Displaced M-14 mines. PRC-74 voice and CW contact maintained throughout entire operation.
87C	XE 4404	111	7	14 May 68	29 May 68	No significant activities; no enemy contact.
87D	XE 5206	120	6	14 May 68		As of 17 May, negative enemy contact. No contact since 170910Z May, vicinity XE 536064. Team missing.
82	XE 363215	122	4	15 May 68	22 May 68	No enemy contact. Team extracted due to illness of one team member.
82A	XE 2631	113	8	22 May 68	7 Jun 68	Resupplied by O-2 (free-fall bundle drop). Mission extended five days for recon of Rte 1961. No significant activities; no enemy contact.
813	XD 569869	114	7	6 Jun 68	18 Jun 68	No contact established 7 June. No enemy contact. "No bomb line" established to protect team. Team leader, assistant team leader and radio operator missing since 12 June. Team conducted roadwatch on Rte 1036. Team observed convoys on Rte 1036 and located truck park and motor pool at XD637842.
811	WE 715900	115	7	19 Jun 68	29 Jun 68	Resupplied 26 June, VNAF A-1. Enemy contact 28 June; no friendly casualties; enemy casualties unknown. Team location compromised; exfiltrated 29 June.
813A	XD 557921	111	8	20 Jun 68	30 Jun 68	Enemy contact on 24 June. No friendly casualties; enemy casualties unknown. Enemy contact on 29 June; one team member KIA; enemy casualties three KIA possible KIA. Team extracted 30 June. Circumstances surrounding the wounding of one team member and inconsistencies noted during debriefing have led to the removal of this team from the STRATA Program. Further investigation underway.

~~TOP SECRET~~

C-b-76a

~~TOP SECRET~~

FIGURE B-16 (Cont'd)

Target		Team		Date		Comments
Designation	Location	Designation	Strength	Infiltrated	Exfiltrated	
B7E	ID 440932	117	7	27 Jun 68	6 Jul 68	No enemy contact. Roadwatch site established Rte 196. No enemy traffic of any description observed during period 1-5 July. Team actually patrolled road and saw no evidence of recent use. Upon completion of debriefing, it was decided that the portion of Rte 196 designated as STRATA Target TE is no longer considered a lucrative target for STRATA operations.
B2B	IX 297376	8118	7	7 Jul 68	14 Jul 68	Mission: Roadwatch of Rte 137. Enemy contact 10 July; M-14 mines emplaced; no casualties. Team pursued by enemy 10-13 July; successfully evaded and extracted 14 July. No casualties; roadwatch mission not accomplished.
B13B	ID 594824	894	7	13 Jul 68	28 Jul 68	Mission: Roadwatch of Rte 103. Team unable to establish roadwatch site because of enemy security in the area. Team identified two other enemy-used trails in area, distributed BSPL material and took photo of area in vicinity of Rte 1036. Team failed to accomplish primary mission of roadwatch. Extracted 28 July.
B4	IX 202458	893	7	15 Jul 68	23 Jul 68	Mission: Roadwatch of Rte 101. On 16 July, one team member sustained leg injury; on 17 July, team reported a shortage of water. On 18 and 20 July, aerial resupply of water attempted in both instances resupply unsuccessful when water containers were broken on impact. Team extracted 28 July; team failed to accomplish assigned mission.
B11A	WE 739891	8115	7	21 Jul 68	14 Aug 68	Mission: Roadwatch on unnumbered routes vicinity WE 810923. Team observed movements of 15 enemy groups (20-30 men each) moving in vicinity WE 742090 on 6 August. Team engaged in firefight with enemy platoon on 7 August. Three team members MIA as result of firefight. Team accomplished primary mission of locating terminus unnumbered road vicinity WE 711923. Secondary mission of locating truck park, vicinity WE 728913 accomplished. Additional mission of distributing BSPL material accomplished at WE 711923. Reports of debrief indicate that three missing team members are still evading; serial search will be continued.

~~TOP SECRET~~

J-1-(16)

Annex B to
Appendix C

FIGURE B-16 (Cont'd)

Target		Team		Date		Comments
Designation	Location	Designation	Strength	Infiltrated	Exfiltrated	
813C	XD 575921	8119	6	29 Jul 68	14 Aug 68	Mission: Roadwatch of Rte 1036, vicinity XD 660945. On 10 August, team leader and scout moved out on recon mission; shortly after, enemy force moved into base camp area and remainder of team evaded. Recon party never rejoined team. While evading main body of enemy troops, team observed new trails in area; two trucks, vicinity XD 688934; two new roads suspected as being by-pass routes for Rte 1036; and observed many woodcutters clearing area. Team emplaced M-14 mines, vicinity XD 659940 and took photo of area, vicinity XD 575924, XD 585919, XD 590923 and XD 635935. Search will be conducted for two missing members.
813D	XD 585845	8116	7	5 Aug 68	16 Aug 68	Mission: Capture NVA prisoner and place M-14 mines on routes of military traffic. Team had no visual or physical enemy contact. Located deserted enemy site containing several ammo, personnel, commo bunkers and several buildings. Team booby-trapped commo bunker with claymore mines. Team did not accomplish primary mission.
82C	XE 264313	8118	6	6 Aug 68	21 Aug 68	Mission: Roadwatch of Rte 137. Enemy contact on 16 August; after short firefight with four enemy, team withdrew. On 18 August, while three team members were photographing area, a company of enemy appeared; after short firefight, team withdrew and emplaced M-14 mines along route of withdrawal. During night of 17-18 August, team observed company of enemy (270 by count) moving SE, vicinity XE 258294, on trail parallel Rte 137. Troops were dressed in black and carried MGs, AK-47s, mortars, and larger, unidentified weapons. Due to heavy enemy activity in area, team not able to conduct roadwatch on Rte 137; observed several unusable trails paralleling Rte 137.
813E	XD 568868	894	7	14 Aug 68	18 Aug 68	Mission: Roadwatch of Rte 1036. On 14 August, four NVA soldiers armed with AK-47s, entered base camp; during a three-minute verbal exchange, NVA personnel urged STRATA team to surrender. Team then opened fire and killed all four enemy personnel. Team then withdrew from base camp after receiving heavy small arms fire from estimated enemy platoon. During withdrawal, team emplaced 13 M-14 AP mines along withdrawal route. Roadwatch mission not accomplished.

TOP

-b-111

Appendix B
Appendix C

TOP SECRET

FIGURE B-16 (Cont'd)

Target		Team		Date		Comments
Designation	Location	Designation	Strength	Infiltrated	Exfiltrated	
4A	IX 247483	893	7	31 Aug 68	14 Sep 68	Mission: Roadwatch of Rte 101. On 3 September from roadwatch site established, IX 249512, team reported observing 16 trucks moving E to W, 30 kmph traveling 10 minutes apart; also reported enemy squad patrols on Rte 101 daily. On 8 September, team withdrew from roadwatch site due to enemy activity in area. On 9 September, team reported two trucks moving E to W on Rte 101. Team further reported on enemy patrols throughout area; no contact with enemy. Team extracted from vicinity IX 248513 at 140635Z Sep. No reports on tactical reaction or exploitation of targets reported by team.
13F	XD 557921	8116	8	9 Sep 68	23 Sep 68	Mission: [REDACTED] On 14 September, ambush site established vicinity XD 557921. On 17 September, team terminated ambush because of no enemy activity in area. From 17-22 September, team patrolled area in attempt to locate enemy. No enemy contact or activity reported. Team extracted from vicinity XD 557923 at 230710Z Sep. [REDACTED]
811B	VE 714777	892	8	15 Sep 68	28 Sep 68	Mission: Area reconnaissance. Team established cache site, vicinity VE 715799; reported slow movement because of difficult terrain. On 19 September, reported location, vicinity VE 712793 of heavily used trail. On 21 September, team successfully evaded enemy patrol. On 22 September, team reported two enemy companies using trail in area; team placed M-14 AF mines on trail and heard subsequent explosions; no enemy contact. Team extracted from vicinity VE 713825 at 280517Z Sep.
52D	IX 384183	894	6	4 Oct 68	28 Oct 68	Mission: Roadwatch of Rte 137. Roadwatch site established at IX 295192 on 10 October; pictures taken of Rte 137 from vicinity IX 284197 to IX 299123. Heavy fog and rain prevented observation during period 11-14 October. New roadwatch site established on 15 October, vicinity IX 285185; more pictures taken of Rte 137 from IX 279176 to IX 284197. Negative enemy contact or sightings.

*Capture
prisoner*

TOP SECRET

C-b-76d

Annex B to
Appendix C

~~SECRET~~

FIGURE B-16 (Cont'd)

Target		Team		Date		Comments
Designation	Location	Designation	Strength	Infiltrated	Exfiltrated	
STP	XE 509098	8118	7	6 Oct 68	21 Oct 68	Mission: Reconnaissance of Loug Dni River for enemy river traffic. Negative enemy contact through 15 October. Adverse weather in OPAIDZA affected radio communication and visual observation. On 16 October, team directed to move to exfiltration LZ for extraction on 17 October. Due to adverse weather, extraction not accomplished until 23 October. During initial debrief, team reported that during several radio transmissions, another station kept coming on air speaking Chinese. This unidentified station attempted to "jam" team transmission. Team reported the Song Loug Dni was at flood stage and not used for transportation.

~~SECRET~~

1-6-76

Form X 1-11
Appendix C

FIGURE B-17 (S)
STRATA TARGET (U)

Target 1^{a/}

Target justification: The target is located vicinity WE 8579 at the junction of NVN National Rte 15 and 101. This is a major fork in the infiltration routes leading from NVN into Laos and SVN. The target area is north of the Mu Gia Pass and contains numerous truck parks, storage and staging areas. SICRs D-133 12429, dated 3 May 66, and U-GAP-13500, dated 30 March 66, requested information regarding enemy infiltration, LOC and transportation. Additionally, 7AF desires information on this target inasmuch as it is a major target for air strikes. A STRATA team operating in Target 1 will be able to provide a comparison of traffic density moving along LOC. Further, it is expected that valuable targeting data can be provided for air strikes. A 15-man STRATA team will infiltrate this target by H-3 type helicopters and remain for approximately 15 days.

Target 2^{a/}

Target justification: The target is located vicinity XE 3435 and is situated along NVN National Rte 137. NVN National Rte 137 is a major supplement to NVN National Rte 15. 7AF is interested in this area. Target 2 is considered a suitable target for STRATA team because of the extremely difficult terrain, which attributes to the scarce habitation in the area and an apparent lack of enemy forces in the vicinity of the target. A 10-man STRATA team will infiltrate this target by H-3 type helicopters and remain for approximately seven days.

Target 3^{a/}

Target justification: The target is located vicinity XD 8388 and is situated along NVN National Rte 103. This area is believed to be an enemy rest area and storage area. Two bridges are located in the target area; however, no truck parks have been noted. Indications are that NVN National Rte 103 is heavily travelled and that trucks are parked at designated sites along the route. A STRATA team can report traffic density along NVN National Rte 103 and provide valuable targeting data for air strikes. A 10-man STRATA team will infiltrate this target by H-3 type helicopters and remain for approximately five days.

a/ COMUSMACV MACSOG 2167/230147Z May 67 (CINCPAC 300117Z May 67)

FIGURE B-17 (TS) (Cont'd)

Target 4a/

Target justification: The target is located vicinity XE 2350 and is situated along Rte 101. It provides the principal transportation link between Rtes 15 and 137, both of which are principal road infiltration routes into Laos. Surveillance of Rte 101 will provide intelligence on the volume and direction of flow of traffic on a principal interior route. In addition, valuable targeting data can be developed for 7AF.

Target 5a/

Target justification: The target is located vicinity XE 1353 along Rte 101. It is considered to be one of the most heavily used routes in NVN. It provides the principal transportation link between Rtes 15 and 137, both of which are principal road infiltration routes into Laos. Surveillance of Rte 101 will provide intelligence on the volume and direction of flow of traffic on principal interior route. In addition, valuable targeting data can be developed for 7AF.

Target 6a/

Target justification: The target is located vicinity XE 3841 and is situated along NVN National Rte 137. DIA intelligence bulletin lists Rte 137 as one of the most heavily traveled routes in NVN, and is a major vehicle concentration area. It is the second major inland infiltration route for supplies to Laos and RVN. At this point, it is fed by Rte 101 from the North. Surveillance of this route will provide information on the volume and direction of traffic flow. In addition, valuable targeting data can be developed for 7AF.

Target 7a/

Target justification: The target is located vicinity XE 5505 west on Rte 196. The condition, status of Rte 196 is not known. Use of the DIA Giang River for movement of supplies and equipment is also unknown. Surveillance of this area will provide information on the status and use of these two routes of movement. In addition, valuable targeting data can be developed for 7AF.

a/ COMUSMACV MACV 4057/230725Z Aug 67 (CINCPAC 312216Z Aug 67)

FIGURE B-17 (IS) (Cont'd)

Target 8^a

Target justification: The target is located vicinity XE 5528 and consists of a series of truck parks along Song Dun, approximately 14 nm from the Laos/NVN border; not associated with any known road. This could be a major storage area or the beginning of a new overland route to Laos. Surveillance of the area will provide information on the size, use and content of the truck park/storage areas. In addition, valuable targeting data can be developed for 7AF.

Target 9^a

Target justification: The target is located vicinity VG 7010 and is situated along Rte 7. It connects NVN Rte 1A and Laotian Rte 13 via the Col Barthelemy Pass and is the primary supply route in support of Pathet Lao operations in the Plaine Des Jarres area. Surveillance of this route will provide information on the volume and direction of traffic flow. In addition, valuable targeting data can be developed for 7AF.

Target 10^b

Target justification: The target is located within the quadrant WE 6095-7095 and F 6005-7005. Reconnaissance of this area is desired to locate unnumbered routes which branch off of Rte 151.

Target 11^b

Target justification: The target is located within the quadrant WE 6585-7585 and W 6595-7595. Reconnaissance is desired to locate an unnumbered route which terminates at WE 713936.

Target 12^b

Target justification: The target is located within the quadrant WE 8365-9265 and WE 8349-9249. Main target is Khe La Mong Road as reported in NIC Interrogation Report (164/68-DOI: June 1966). Road supposedly begins at Rte 101 and crosses the Laotian border southeast Mu Gia Pass.

a/ COMUSMACV MACSOG 4057/230725Z Aug 67 (CINCPAC 312216Z Aug 67)

b/ COMUSMACV MACSOG 1985/140412Z Apr 68 (CINCPAC 160524Z Apr 68)

FIGURE B-17 (1) (Cont'd)

Target 13^{a/}

Target justification: The target is located within the area XD 5991-6991 and XD 6981-5981. Reconnaissance of this area is desired to determine enemy motorized and foot traffic on Rte 1038, known as Bat Lake (LAC XA) road which extends from XE 808063 (Rte 101) to XD 664782. Aerial photography does not reveal any further extension of this road South or West. Road is reported serviceable and heavily traveled. Tracked and wheeled vehicle tracks are very apparent from photo read-outs. Target is within helicopter range of Nakhon Phanom.

Target 14^{b/}

The target is located within the area of WF 2645-4025 and WF 2627-4027.

Target 15^{b/}

The target is located within the area of WF 2053-3553 and WF 2037-3537.

Both target areas are located near the Laotian border and are approximately 40 kilometers southwest of Vinh (WF 7164). Each area measures 14 x 18 km with about one-third of each area overlapping the principal roadwatch target Rte 8. Target areas are between 18° 20 minutes and 18° 34 minutes parallels and are not affected by present overflights and ordnance restrictions. Both target areas are within helicopter flight range from Nakhon Phanom, Thailand.

a/ COMUSMACV MACSOG 2625/200200Z May 68 (CINCPAC 220409Z May 68)
b/ COMUSMACV MACSOG 3792/210720Z Jul 68 (CINCPAC 232118Z Jul 68)

FIGURE B-18 (T)
STRATA MISSION DATA (U)

Seq No.	Team	Tgt Area	Dates	Mission	Remarks
1	111 (8 VN)	7	17-23 Mar	Roadwatch	Enemy contact 18 Mar
2	113 (8 VN)	7	31 Mar-7 Apr	Recon/Roadwatch	N/A
3	114 (8 VN)	7	7-15 Apr	Roadwatch	Enemy contact 9 Apr
4	120 (6 VN)	7	14-17 May	Riverwatch	Contact lost 17 May; Tm declared MIA.
5	111 (7 VN)	7	14-29 May	Roadwatch	N/A
6	122 (4 VN)	2	15-22 May	Roadwatch	N/A
7	113 (8 VN)	2	22 May-7 Jun	Roadwatch	N/A
8	114 (7 VN)	13	6-17 Jun	Roadwatch	3 MIA on 12 Jun
9	115 (7 Camb.)	11	20-29 Jun	Recon	Enemy contact 27 Jun
10	111 (7 VN)	13	20-30 Jun	Recon/Road- watch	1 self-inflicted wound; extracted
11	117 (6 Camb.)	7	27 Jun-6 Jul	Roadwatch	N/A
12	118 (7 VN)	2	4-14 Jul	Roadwatch	Enemy contact 10 Jul
13	94 (8 VN)	13	13-28 Jul	Recon/Road- watch	Enemy contact 17 & 21 Jul
14	93 (8 VN)	4	15-23 Jul	Roadwatch	N/A
15	115 (7 Camb.)	11	21 Jul-14 Aug	Recon	Enemy contact 7 Aug; 4 MIA
16	119 (6 VN)	13	29 Jul-14 Aug	Roadwatch	2 MIA
17	116 (7 Camb.)	13	5-16 Aug	PW	N/A
18	118 (6 Camb.)	2	6-21 Aug	Roadwatch	Enemy contact 16 & 18 Aug
19	94 (7 VN)	13	14-19 Aug	Recon/PW	Enemy contact 14 Aug
20	93 (7 VN)	4	31 Aug-14 Sep	Roadwatch	N/A
21	116 (8 Camb.)	13	9-23 Sep	PW	N/A
22	92 (8 VN)	11	15-28 Sep	Recon	N/A
23	94 (6 VN)	2	4-23 Oct	Roadwatch	Enemy contact 17 Oct
24	118 (7 Camb.)	7	6-23 Oct	Riverwatch	N/A

FIGURE B-19 (TS)
STRATA TARGET AREAS AND MISSIONS (U)



F. (T) SINGLETON OPERATIONS

1. (T) Policy. Singleton agent operations, under the agent team program rules, required case-by-case approval at the Washington level.

2. (T) GOLDFISH and PERGOLA

a. Background. The concept of operations* as submitted in July 1967 by COMUSMACV was to utilize two PLOWMAN(C) detainees as returnees to their former fishing occupation to collect intelligence information. No communications were planned during the 60-90 day mission. Exfiltration would be by SOG/STD PTF pickup on initiation of the proper recognition signal by the agents. Debriefing would then follow. This initial insertion was the forerunner of the maritime diversionary program; Project URGENCY, which was conducted in 1968. Authority to infiltrate GOLDFISH and PERGOLA was forwarded by JCS in August 1967.**

b. Operations. The two agents were trained at Paradise Island (see Annex on psychological operations) for low-level intelligence collection in their home areas, and were returned to NVN by PLOWMAN(C) mission 327 on 13 September 1967. No contact was expected for 60-90 days; however, there is no record that either of the agents ever made an attempt to be retrieved as planned.

3. (S) Gray Singleton Operations

a. Background. In August 1968, MACSOG proposed to CINCPAC JCS a concept*** for using gray singleton agents to collect information in selected populated centers in NVN. The agents selected were to be documented as NVN soldiers and were to remain in the selected center of operations for one to two weeks only. Two agents, ROMA and AURORA, were recruited in 1968 from the National Chieu Hai Center in Gia Dinh. The

* (T) Msg, COMUSMACV, DTG 250812Z Jul 67
** (T) Msg, JCS, DTG 141905Z Aug 67 (SACSA)
*** (S) Msg, COMUSMACV, DTG 180520Z Aug 68 (SACSA)

proposed target areas in order of priority were: Vinh, Thai Tru, Anh Son, Dong Hoi, Thanh Hoa, Ha Tinh, and Sam Son. The proposal as outlined above was approved by CINCPAC*, but the imminence and final promulgation of the bombing halt decision of 1 November delayed JCS approval until the possibility of conducting the operations was overtaken by events.**

b. ROMA. Subsequently, the target area for ROMA was changed to an intelligence mission in Cambodia. ROMA was launched on this mission on 1 December 1968, but was not heard from again. He was declared missing in action on 15 December 1968.

c. AURORA. Agent AURORA was infiltrated into Cambodia for a short-term observation mission. The agent carried a beeper radio which enabled central contact to monitor his progress. The agent moved to the target area and returned to the exfiltration LZ; however, there was no further contact and the agent was not recovered.***

d. DIE HARD. This agent was to carry out a mission in Cambodia in two phases. Phase I commenced on 9 April 1969 and had as its objective to determine whether placement was feasible in the target area, Mimot, Cambodia. Because of the inaccuracy of the documentation provided, the agent was stopped and arrested during a cursory check in Kompong Cham, Cambodia. By bribing the local police official, DIE HARD was able to return to South Vietnam. It was planned to attempt Phase I again, beginning on 12 July 1969.***

* (S) Msg, CINCPAC, DTG 080032Z Sep 68 (SACSA)
** (TS) History, MACSOG, "Annex F to MACV Command History, 1968," p. F-III-4-3 (SACSA)
*** (T) Memo, MACSOG-36, "Status of Singleton Agent Program," 17 July 1969 (SACSA)

G. (TS) DIVERSIONARY OPERATIONS

As mentioned briefly in Part I of this Annex
 diversionary operations were conceived in late 1967 and were
 well underway in 1968 when the bombing halt in November
 limited all activities except certain psychological aspects
 of the operations. The formal program initially consisted of
 six projects as approved verbally by COMUSMACV on 14 March 1968.
 The program was to be conducted primarily within the authorities
 for FOOTBOY(C) already in approved at the JCS or CINCPAC level.
 Those operations that exceeded established authorities ^{were} submitted
 to CINCPAC for approval on a case-by-case basis.* Three of the
 six projects were transferred from TIMBERWORK(C) to HUMIDOR(C)
 for implementation. The three remaining programs in TIMBERWORK(C)
 are described below.

1. (TS) "Project OODLES(C)". This project is designed to
 portray an apparently extensive and successful clandestine agent
 network in selected areas of NVN. Conduct of this project
 parallels conduct of the in-place long-term agent team operations
 and becomes more credible by NVN knowledge of captured actual
 teams. Family messages are sent via HUMIDOR(C) SSPL one-way
 voice link and the notional teams are resupplied in the same
 manner as actual teams. To add credibility, personnel presence
 is implied by the parachuting of an ice block weighted personnel
 parachute to be found, after the ice melts, hanging in trees.
 Another method is actual infiltration of a pseudo-agent who is
 led to believe he was separated both from team members who were
 to have received him on a drop zone and from other team rein-
 forcements seen in the aircraft. The reinforcement seen by the
 pseudo-agent are actually RVNAF cadre and do not exit the air-
 craft as the agent is led to believe. Eighteen notional teams
 were authorized by CINCPAC for activation in 1968. Fourteen of
 them have been activated via message traffic. Of the fourteen
 activated teams, eight have been geographically located by bundle
 and notional personnel parachute drops. Two teams have been
 notionally reinforced by the actual infiltration of pseudo-
 agents.*** Following the bombing halt messages were sent to each
 team every other month. The messages were comprised mainly of
 family news and code instructions. The name of the notional
 team was given, but not its location (see Figure B-20).

2. (TS) "Project URGENCY(C)". This project involves the use
 of fishermen captured during PLOWMAN(C) operations as pseudo-
 agents and, where possible, actual agents. The objectives are
 to divert NVN security forces to apprehend, detain, interrogate,
 and investigate fishermen implicated as agents and, if not dis-
 covered, to collect intelligence. During HUMIDOR(C)'s SSPL
 orientation of those fishermen captured, the cooperative, more
 intelligent were recruited and trained as low-level agents, then

* (TS) Historical Summary, Airborne Studies Group, "SOG Annual
 Historical Summary," 5 Jan 69, p. 12 (SACSA)

** (TS) History, MACSOG, "Annex F to MACV 1968 Command History,"
 p. III-4-5 (SACSA)

returned to NVN to be recontacted at a later date. NVN cadre, militia, or other fishermen who will not benefit the SSPL and/or are uncooperative are returned to NVN far from their homes with money or messages planted in their clothing, or are obviously implicated as agents in other ways. To date, there have been eleven low-level agents and two pseudo-agents launched into NVN. The PLOWPLAN(C) restrictions on capturing fishermen suspended all URGENCY(C) operations in May, but the partial lifting of restrictions in July allowed a limited resumption until 1 November at which time restrictions imposed suspended the URGENCY(C) program."* (See Figure CB-21.)

3. (TS) "Project BORDEN(C). This project employs NVA ralliers and prisoners of war to convince NVN that a successful penetration of the NVA is being conducted with the mission of inducing defection and collecting intelligence. The project is designed to divert military resources to counter this penetration, harass and alienate NVA troops from their leaders, strain NVN ideological control, induce defection and collect intelligence. NVA soldiers are collected from division level detention facilities as soon after capture as possible, oriented for two weeks on the freedom and prosperity of RVN at a centralized security facility, and in other ways convinced to support the RVN; trained one week as agents; and infiltrated into NVA-controlled territory of RVN, Laos, Cambodia and NVN. The agent's mission is to return to the NVA as an escapee or under other appropriate cover, collect intelligence, recruit dissatisfied soldiers through the use of a secret 'CHIEU HOI' pass (ultra-violet mark on the prospective rallier) and exfiltrate through defection. It is fully expected and intended that many of the recruited agents will reveal their assigned mission to the NVA of their own volition or under interrogation. Those NVA soldiers not recruited as agents during the orientation period are returned to normal detention facilities to spread specifically revealed project information to these detainees for eventual transmission to NVA intelligence analysts. For CY 1968, 98 detainees have been collected for this project. Fifty of them were returned to detention facilities, 44 were inserted as agents into NVN- and NVA-controlled territory of RVN, Laos and Cambodia. Four agents are scheduled for insertion in January 1969. Five agents have been recovered and three reinserted; one in NVN in support of both Project OODLES(C) and Project BORDEN(C); and two in Laos."** This project was continued into 1969 with agents dropped into both Laos and Cambodia. During the spring months, 12 agents per month were dropped; at mid-year, the number was reduced to three per month. (See Figure SB-22.)

H. (TS) EARTH ANGEL

The EARTH ANGLE program was conceived in the spring of 1969 to indoctrinate carefully selected Chieu Hoi personnel as intelligence agents for insertion into Laos. The authority for and operations conducted in this program are covered in the appendix on operations in Laos. The training and control of these agents were under the direction of CP-36 (Airborne Studies Group).

* (TS) History, MACSOG, "Annex F to MACV 1968 Command History," p. III-4-5 (SACSA)

** (TS) History, MACSOG, "Annex F to MACV 1968 Command History," p. III-4-6 (SACSA)

FIGURE CB-21 (TOP)
PROJECT URGENCY(C)

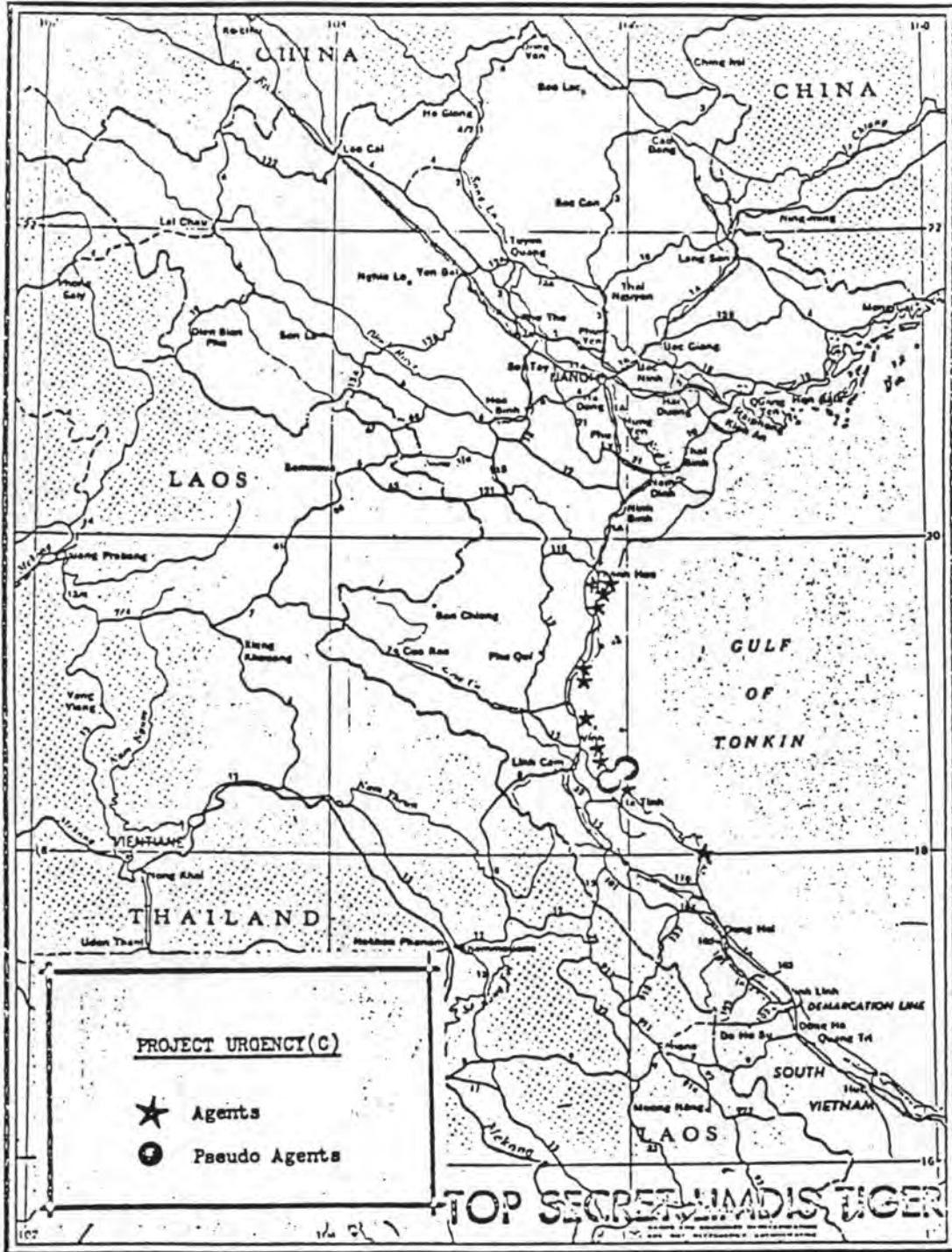
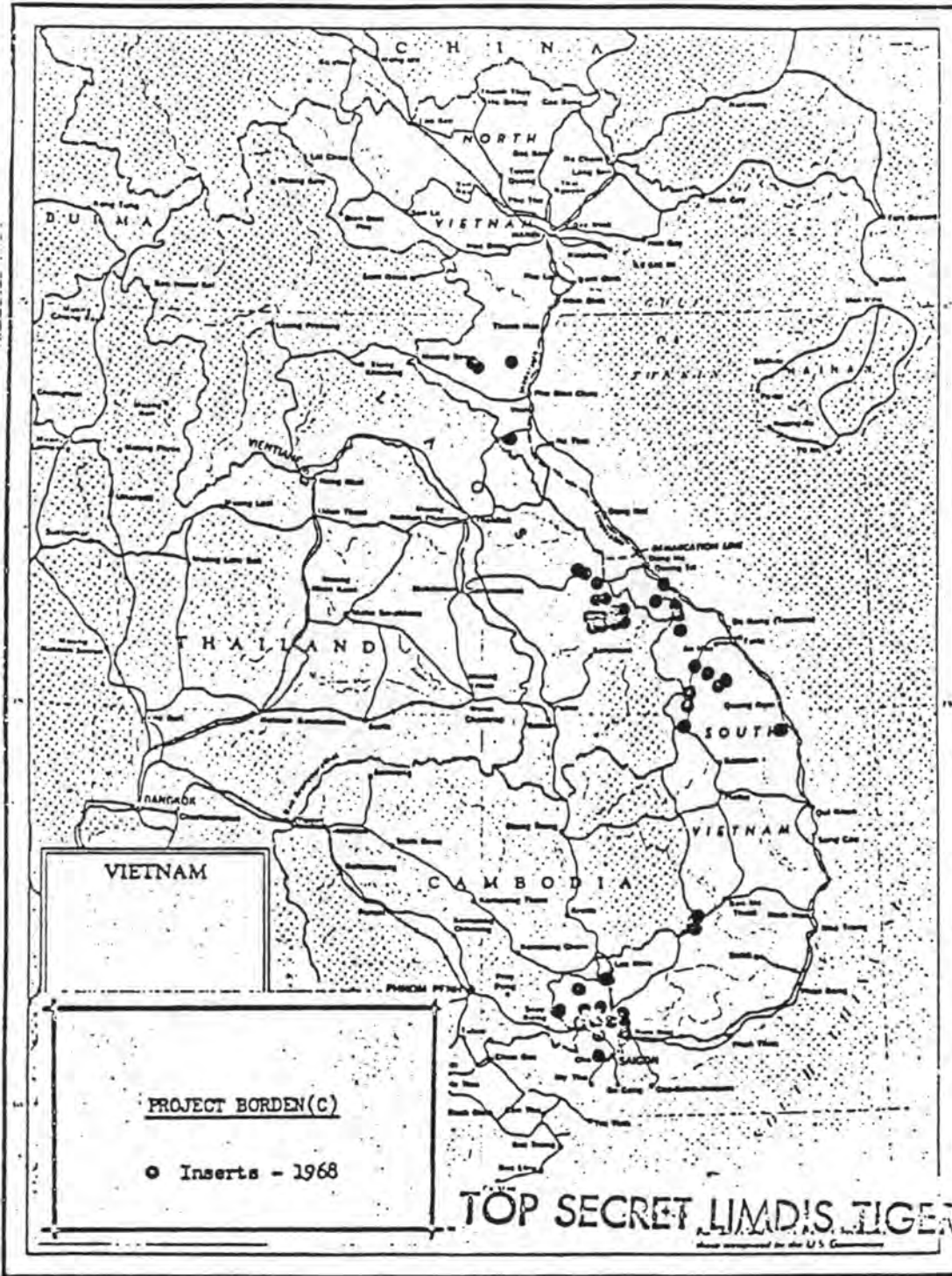

FIGURE CB-22 (TS)
PROJECT BORDEN(C)



PART IV. PROBLEM AREAS (U)

A. (TS) PROBLEM AREAS - AIRBORNE OPERATIONS

The problem areas that have plagued airborne operations from 1964 through 1968 are codified chronologically below:

B. (S) CHRONOLOGY

1. (TS) 1964

a. "Ground rules which limit Airborne Operations ability to increase pressure on DRV:

(1) "Deployed teams are restricted from contacting population or starting resistance.

(2) "Restriction on overflight of Laos (lifted 24 May 1964).

(3) "Restriction from using third country airfields for staging bases has caused extreme range, load, and weather problems.

(4) "Restriction from use of helicopters to emplace and resupply agent teams deprives SOG of operational flexibility and limits potential. Request was denied on 18 April 1964.

(5) "CAS Vientiane's refusal to make assets available to SOG.

b. "Weather and Terrain

(1) "The DRV as a whole has some of the poorest flying weather in the world and some of the roughest terrain. These obstacles have held airborne operations at an unproductive level.

(2) "The mountains and fogs force the C-123 aircraft to operate only during light of moon periods, i.e., 10-12 nights a month.

(3) "The rugged terrain which aids the agents in maintaining their security produces little survival food and greatly hinders movement.

c. "Enemy

(1) "The DRV employs large numbers of AAA weapons which severely restricts resupply operations. Aircraft are not allowed to fly within range of these guns even if masking terrain is present.

d. "Counterpart Relations

(1) "SOG and STS Headquarters are distant physically. This makes direct liaison difficult. The telephone cannot be used because of security precautions. A liaison officer is assigned but much is still desired in the form of a closer relationship.

(2) "US security regulations render it impossible for STS personnel to visit SOG working areas.

1
2
3
4
5
6
7
8
9
10
11
12
13
14
15
16
17
18
19
20
21
22
23
24
25
26
27
28
29
30
31

(3) "A few of STS officers are ineffective. However, it is difficult to have such individuals replaced.

e. "Equipment

(1) "Principal weakness of Airborne Operations is the lack of operational aircraft. The C-123 load capacity, operating range, and inability to fly in adverse weather greatly hampers airborne operations. " *

2. (1) 1965

"a. Limitations on Aircraft (numbers and types)

"(1) Airborne operations during the past year have been hampered by the limited numbers and the types of aircraft available for employment by this section. During any given launch period, no more than two C-123 aircraft are usually available at the same time. An additional four H-34 helicopters VNAF crews, currently supporting Shining Brass operations, are available for periodic employment in 34A programs. These helicopters however, are generally unsuitable to 34A operations because of range and cargo carrying limitations.

"(2) In order to adequately support the present in-place teams, and to have the capability of introducing and supporting additional teams in NVH, a combination of helicopters and fixed wing aircraft are needed. The helicopters, with a suitable range and lift capability, will insure the relatively safe delivery of an intact operational team to a pre-selected point. A fixed wing aircraft with a greater cargo load (ACL) than that of the C-123 aircraft, and possessing the capability of flying missions independent of the moon period will permit two or three resupply operations to be flown on one sortie.

"b. Inadequate Base Rights

"(1) SOG C-123 aircraft are permitted to fly infiltration, reinforcement and resupply missions from [redacted] and [redacted] by agreement with RTG. Agent teams may be transloaded from SOG C-123s to CAS helicopters at [redacted] for infiltration to LZs in (Laos) per agreement with RTG, but not at [redacted]. In addition, VNAF helicopters may be used to deploy teams into the NVN from bases in SVN. No authority exists, however, for deployment of agent teams by CAS helicopter into the NVN; deployment of agent teams by VNAF helicopter from bases [redacted] into the NVN; use of intermediate staging areas in Laos for refueling VNAF helicopters incident to infiltration of agent teams into NVN; use of US crews in support of 34A operations in the NVN; or use of [redacted] station at [redacted].

"(2) Projected airborne operations during 1966 will place heavy demands on all available resources to emplace operational teams. Four new operational areas are scheduled for activation. Delivery techniques must offer the highest assurance of emplacing all team members in or near the operational area. Helicopter infiltration is considered the best method of doing this. Yet, all areas programmed for activation

* (1) History, MACSOG, "Annex A to MACV Command History 1964," p 19-22 (SACSA)

are beyond the limits of missions which can be flown in the VNAF helicopters from bases in SVN. Additionally, all areas are beyond, or marginally close to, the practical limits of range and cargo capability of the H-24 helicopter operating from Nakhon Phanm. At the end of the year, consideration was being given to requesting CINCPAC views on expansion of base rights in Thailand and Laos.

"c. Limited Coordination Between CAS Operations in Laos and SOG Operations in NVN:

"(1) Joint DOD-CAS message 062143Z Jul 65 states that COMUSMACV is responsible for overall planning of all anti-NVN military or paramilitary operations within NVN and should be fully consulted during the execution of such operations.

[REDACTED]

An unknown number of CAS LZs and airstrips in Laos are possible support bases for 34A operations. As a result of this situation, no 34A operation to date has brought CAS and 34A assets together.

1.5(e)
3.4(b)(1)

"(2) CAS assets in Laos could assist SOG operations against NVN considerably. CAS could contribute to SOG effort by securing intermediate staging areas [REDACTED] at ISAs [REDACTED] and pre-stocking them with fuel to facilitate operations by helicopter. They could assist resupply of link-up operations between CAS controlled guerrilla forces [REDACTED] and 34A in-place teams. Finally, they could establish procedures and safe areas [REDACTED] facilitate movement of teams or individuals [REDACTED] Laos for subsequent exfiltration. At the end of the year, consideration was being given to requesting CINCPAC views on seeking greater CAS cooperation and participation in 34A operations." *

1.5(e)
3.4(b)(1)

3. (S) 1966

a. Aerial Photography Problems. Chief, SOG requires that aerial photography of the DZ/LZ be accomplished and interpreted not earlier than five days prior to a scheduled infiltration into NVN, before human resources may be committed. This is necessary in order to determine the most recent changes in vegetation, human habitation, or military activity in the operational area, as an added safety precaution for the infiltrating teams. Adverse weather conditions in NVN have delayed timely aerial photography of operational areas. Additionally, in several instances, SOG priority photography missions have had to give way to other priority missions. In either case, delay was caused in scheduled infiltrations.

"b. Exfiltration. Two attempts to exfiltrate several members from Team TOURBILLON ALFA in September and Team HECTOR in December were cancelled because Team TOURBILLON ALFA failed to establish radio contact prior to the scheduled exfiltration LZ. The inability so far to exfiltrate team members has had an adverse effect on the retention of agent trainees. Exfiltration attempts will continue to be made.

* (S) History, MACSOG, "Annex N to MACV Command History 1965," p 7A-19 (SACSA)

A concept to exfiltrate Team BELL was developed and forwarded to CINCPAC on COMUSMACV msg DTG 160720Z Jan 67. A successful team exfiltration will demonstrate dramatically to agent trainees that agents can be brought safely out of NVN. Further, agent losses will be curbed if exfiltrations can be accomplished successfully.

"c. Communications. Real-time road/rail and river watch reporting cannot be effected presently because the communications arrangement allows only one daily two-way contact between base radio (Project BUGS) and in-place teams. Although this contact is supplemented with additional contacts when possible, adverse weather affecting wave propagation often prevents usable contact during certain periods. In addition, base radio station at present cannot handle all traffic simultaneously. The Radio, RS-1, the principal team radio, is unwieldy. Although it can be man-packed, it becomes ponderous when carried cross-country over difficult terrain for extended periods. Lightweight radios are being produced, and the DELCO Model 5300 Radio was requisitioned for field suitability testing. Two DELCO Model 5300 Radios, together with 16 transceiver crystals, antenna, carrying case, 10 batteries, battery charger with one-year supply of spare parts, valued at \$5,221.00 were requisitioned with a priority 5 from the Counterinsurgency Supply Office, Okinawa, Ryukyu Islands on 26 April. The radios and not been received at the end of the year.

"d. Resupply. Aerial resupply was one of the biggest problems in keeping in-place teams viable. High performance aircraft are employed to effect resupply to in-place teams whose operational zones are within the surface-to-air missile ring. This resupply technique has distinct limitations. DZ markings are imperceptible and delivery accuracy is not often achieved. Further, if delivery is effected in areas other than the intended drop zone, the dropped supplies will imperil the team if discovered by unfriendly citizenry or security forces. Adverse weather conditions continue to affect resupply deliveries to in-place teams. Additionally, some operational zones are located in areas where drop and landing zones are scarce and areas suitable for drop and landing zones are difficult to establish and operate.

"e. Contact with Enemy Forces. NVN Government has been and will continue to exert a concerted effort against the OPLAN 34A Program. Several in-place teams have encountered enemy forces on repeated occasions recently, resulting in the loss of several team members. Inasmuch as two-thirds of all OPLAN 34A Airborne have been listed as lost since the program's inception in early 1960, the current situation is not unprecedented; however, the pressure exerted by the enemy appears to be better organized and employed more universally throughout NVN. Efforts have been made to minimize communications between the base station and in-place teams, and currently deception and diversionary tactics are being employed in the resupply drops in an attempt to gain some relief for the teams."

4. (S) 1967

"a. Aerial Photography Problems. Chief SOG requires that aerial photography of the DZ/LZ be accompanied and interpreted not earlier than ten days prior to a scheduled infiltration

* (S) History, MACSOG, "Annex M to MACV Command History 1966," p. 74-76.

into NVN. This is necessary to determine the most recent change in vegetation, human habitation, or military activity in the operational area as an added safety precaution for the infiltrating teams. Adverse weather conditions in NVN have delayed timely aerial photography of operational areas. Also, in several instances SOG priority photography missions have had to give way to higher priority missions. In either case this caused delays in scheduled infiltrations.

"b. Exfiltration. Several attempts were made to exfiltrate long-term teams from NVN, but as in the past all efforts were unsuccessful. In February helicopters attempting to exfiltrate team BELL reached the LZ, but the team had departed and in March contact with the team was lost. In June the exfiltration of team VERSE was frustrated when a US aircraft was shot down near the LZ and contact with the team was lost, presumably as a result of increased enemy activity in the area. In June a concept to forcibly exfiltrate team ROMEO, suspected of being under enemy control, was disapproved by CINCPAC because the possible benefits to be derived did not warrant the hazards involved. A plan to exfiltrate two members of team REMUS via Fulton SKYHOOK was abandoned when enemy security patrols discovered the cached equipment. In spite of the difficulties experienced with long-term teams, the feasibility of recovering agents from NVN was sustained when team STRATA III was exfiltrated by USAF Ch-3 helicopters on 28 September 1967. This was the first successful exfiltration of a TIMBERWORK (C) team from NVN.

"c. Contact with Enemy Forces. The NVN government has intensified internal security measures and has employed all available communications media to make the population aware of the presence of SVN "spy-rangers" in their midst. In-place teams continued to encounter enemy forces and suffer casualties as a result. The current situation is not unprecedented in as much as many agent teams have been lost to the enemy since the program's inception in early 1961. However, the pressure now being exerted by the enemy appears to be well organized and employed throughout NVN. Recent actions to develop a wide ranging diversionary program are expected to diminish the effectiveness of the NVN security apparatus by provoking time consuming and fruitless counteractions.

"d. Security Review. At the request of Chief SOG, CAS counterintelligence specialists completed a review of all active OP-34 teams on 2 July. The results of the findings were:

"(1) Probably under hostile control: ROMEO, HADLEY, TOURBILLON and ARES.

"(2) Doubtful status: EAGLE.

"(3) Probably not under hostile control: REMUS, EASY, EASY ALFA and VERSE.

"(4) Missing/captured (not reviewed): BELL and HECTOR.

"(5) As a result of these findings SOG has conceived and developed a diversionary program to turn these liabilities into assets, and is continuing contact with the enemy controlled teams in order to exploit them for diversionary purpose." *

* (S) History, MACSOG, "Annex G to MACV Command History 1967," pg III -4-27,28 and pg III -4-E 6-2 (SACSA)

5. (T) 1968

"a. Lack of adequate aerial photography. Prior to 1 November bombing halt which restricted TIMBERWORK (C) operations in NVN, a combination of adverse weather conditions, higher priority missions of other agencies and the 1 April reduction in bombing activities serve to delay timely receipt of aerial photography. In many cases, lack of appropriate photography caused delays in planning and scheduling of missions. This will undoubtedly continue to be a problem in the event operations in NVN are resumed and an effort to obtain assignment of higher mission priorities would seem to be the only solution.

"b. Difficulty in Resupply Operations. Considerable problems were encountered in attempted resupplies of both long-term and STRATA teams during 1968. Restrictions on overflights of NVN north of 20° N after 1 April and of NVN-controlled teams by CINCPAC direction, are conditions that cannot be resolved at MACSOG level. Adverse weather and team error are also unresolvable problems. STRATA resupply difficulties were primarily caused by improper techniques and bundle configuration. Experimentation and testing had all but resolved these problems before the 1 November bombing halt suspended STRATA infiltration in NVN.

"c. Lack of Required Equipment. A general shortage of NNA uniforms and equipment has continuously hindered efforts to deploy agents and teams clothed and equipped in such a manner as to be able to pass at a distance as NVA personnel or possibly survive a chance encounter. Although efforts were made to obtain captured equipment from units in RVN in 1968, no workable system was implemented to insure that equipment was reserved for MACSOG. Efforts to initiate manufacture of needed items had not been successful as of the end of 1968.

"d. Difficulty in Aircraft Observer/STRATA Team Contacts. Inherent difficulties in working with brevity codes and a language barrier resulting from utilization of non-VN speaking observers caused communications between aerial observers from NKP and deployed STRATA teams to be inadequate. Diplomatic restrictions which prevented VN personnel from remaining in Thailand over 24 hours precluded use of VN observers. Unless this diplomatic restriction is lifted, it is anticipated that this problem will continue during missions controlled by NKP, whether operations in NVN are resumed, or during interim operations in PF/DB AOS. A change to the MACSOG JTD which will incorporate US operations officer/observers with VN language capability will greatly alleviate this problem." *

* (S) History, MACSOG, "Annex F to MACV Command History 1968,"
PF III -4-8 (SACSA)

PART V. EVALUATION (U)

A. (S) SACSA EVALUATION 1964

1. (S) The confusion over the mission of agent teams is evident in a memorandum written by SACSA in August 1964. It states that along with other psychological weapons (radio, leaflets, mail) specially trained teams were introduced into North Vietnam to "create either a real or notional resistance movement within the DRV."* As discussed earlier, the resistance movement was not to be approved at the Washington level. (See Annex A for a discussion of "Resistance Movement".)

2. (S) An evaluation of recruiting problems and prospects was included in the memorandum:

"The problem of team selection and targeting is complex and requires consideration of the various factors of ethnic origin, religion, location of families, motivation, intelligence, and an assessment of the individuals will to survive and resist. North Vietnam breaks down territorially into two distinct areas. One area is the mountainous tribal region of western and northwestern NVN. Here the Meo tribe offers the best chance of success because of its native, hostile attitude towards all non-Meo people. The other area is the Vietnamese inhabited lowlands which comprise the Red River Delta system and the coastal plain. Here the communists exercise almost complete control over the people which makes it difficult to establish large-scale resistance. Any successful development would be expected to remain passive and unorganized. In spite of these difficulties, efforts have been underway to create a credible resistance movement in NVN.

"It is to be noted that within the largely Meo-dominated western and northwestern parts of NVN, there are other ethnic geographic divisions which compound the selection problem. Simply stated, all precautions must be taken to match the team personnel with its drop location.

" With due consideration given to ethnic groups, religion, and family location, experience so far has shown that the military services of the RVN are more desirable as sources for additional agent/team members. Qualified civilians will continue to be selectively recruited as required."**

* (S) Memorandum, SACSA, "Psychological Operations Teams - North Vietnam," 6 Aug 64. (SACSA)

** (S) Ibid., pp 1-2

3. (S) The memorandum concludes with an overall evaluation including some problem areas and expectation for the future:

1
2

"Early infiltrations [redacted] were forced to remain dormant because of the difficulty of achieving resupply. Their main task was survival. The resupply attempts were largely unsuccessful because of the enormously difficult task of locating tiny drop zones in jungle areas where no navigation aids exist. It is known that four members of one team died from malnutrition. The same team was finally successfully resupplied in July after more than a year of living off the land.

3(e)
2.4(b)(1)

"This problem has now been solved by the installation of precise navigation equipment in the delivery aircraft.

"The exact nature of the team PsyOps activities is unknown. As can readily be understood, radio communications with these teams is very difficult technically, and is extremely hazardous for the team. Messages transmitted by the teams are, therefore, very short - they can listen much more safely than they can talk.

"In addition to these problems, and as already stated, the objective is long range. Results are not expected at any specific date. The potential for establishing a resistance base, however, is now in place and, for the time being, relatively well supplied."*

B. (S) COMUSMACV EVALUATIONS, 1966

3
4
5
6
7
8

The increased interest in intelligence collection capabilities in 1965-1966 prompted the following evaluations of the agent teams contributed to intelligence by MACV/MACSOG in the late 1966.

1. (S) The following is quoted from the COMUSMACV message report:

"a. Summary: As of 1 Nov 66 MACSOG had twelve agent teams in North Vietnam, comprising 102 individual agents. From 1 January to 1 November 1966, nine of these teams produced 73 intelligence reports. The three newest teams, KERN, HECTOR, and SAMSON, infiltrated in 1966, have not as yet produced intelligence information. Productivity of the different teams and the topics covered in the reporting are discussed in detail below, but in general the information produced is of intelligence value. The teams have become increasingly responsive to priority collection requirements in the past four months, with different teams reporting on two Priority 1 SICR topics. The production average of the twelve reporting teams has been somewhat less than one report per month per team

* (S) Ibid., pp 2-3

during the first ten months of 1966. Several of the older teams were originally dispatched with primary missions in the sabotage and psywar fields, and their operational areas were not selected with intelligence access as the primary criterion. These teams are the only assets on the ground in NVN responsive to U.S. collection requirements.

"b. Productivity: The listing below, for each of the nine teams which produced intelligence between 1 Jan and 1 Nov 1966 illustrates the difference in productivity for the various teams.

<u>Team</u>	<u>Location</u>	<u>Reports</u>	<u>Comment</u>
ARES	XJ 950275	17	Several subources in populated areas.
EAGLE	XJ 592856	6	Two subources in local population.
BELL	VK 433303	1	Team in strongly patrolled area; two fire fights in last six months.
REMUS	UJ 155987	10	Subsource in local population.
EASY	UJ 545618	10	Six subources in local population.
EASY ALFA	UJ 573452	14	All roadwatch information.
TOURBILLON	VJ 130260	9	None
VERSE	VJ 524081	5	None
ROMEO	XD 690858	1	Team lost 3 members in friendly bombing Jul 66; area heavy with enemy activity.

"c. Extent of Coverage: Only one MACSOG team (ARES) has been able to establish and sustain itself in a key populated area close to priority intelligence targets. Of the others, three (ROMEO, HECTOR and KERN) are in high troop density areas along the NVN/Laos border north of the DMZ, while six (TOURBILLON, REMUS, EASY, ALFA, VERSE and SAMSON) are in or on the fringes of the thinly populated northwest-tribal highlands west of 105 degrees. Some of these teams can cover road traffic into Laos. The one team (BELL) in a location to cover the important trail and river traffic from China along the Lao Cai-Yen axis is in survival status and has had several losses from heavy enemy security patrol actions in the area. The remaining team (EAGLE) has two productive subources in the local population, but the area is fairly remote. Team reporting, except for

ARES, covers local security measures, efforts to indoctrinate and control the tribal populations, and roadwatch information of moderate intelligence value. During November 1966 teams REMUS and EASY have submitted four spot reports concerning the alleged presence of Chicom troops in the vicinity of Dien Bien Phu, a subject of highest priority.

"d. Value: The primary source of all clandestine intelligence reports on North Vietnam received by MACV is MACSOG. Any reports are acquired through direct observation by trained sources. These form an important part of the intelligence data base available on the target country. Several DIA evaluations of OPLAN 34A team reporting have been received and the typical evaluation is as follows:

Validity: Probably true
Usability Value: Moderate
Available from Other Sources: Never or rarely
Timely When Written: Yes
Timely When Received: Yes
The comment column usually includes the remark:
Continued reporting will be appreciated.

"e. Plans for Improving Collection and Reporting:

- (1) Continue to resupply 12 in-place teams.
- (2) Reinforce teams REMUS, SAMSON, TOURBILLON, EASY, EASY ALFA and VERSE.
- (3) Infiltrate teams HADLEY and HANSEN.
- (4) Develop key operation areas in the Lao Cai, Lang Son, and Mong Cai regions.
- (5) Exfiltration of team BELL and infiltration of replacement team."*

2. (S) MACSOG made a study in early 1967 of operations conducted in 1966 /to determine the effects on NVN of the Plowman (C) and Timberwork (C) programs. The following were the conclusions of the study with regard to SOG's agent team operations during 1966:

"a. One hundred and one (101) Intelligence Spot Reports were produced by the teams during 1966. These included the only known sightings in NVN, by personnel under US control, of Chinese (at Dien Bien Phu) as well as reports concerning captured US air personnel.

"b. Sporadic sightings of team members, occasional firefights with those teams, plus the continuous radio traffic emanating from team operations all over the country, have imposed additional control requirements on the NVN security apparatus. This is reflected both in the increased patrolling in the team areas as well as in the continued demands by Hanoi for public alertness against RVN spies.

"c. The presence of the agent teams with their subversive potential in the mountainous areas, has

* (S) Msg, COMUSMACV, DTG 010930Z Dec 66.

~~TOP SECRET~~

probably helped to prompt NVN leaders to apply the carrot-and-stick routine to the tribal populations in the country's Northwest highlands. Persistent efforts to control and indoctrinate the tribes, combined with the preferential treatment of cooperative tribal youths, indicate the regime's concern over possible dissidence being spread to the highlands."*

* (S) MEMO, MACSOG to CINCPAC, "Effects on NVN during 1966 of SOG's Plowman (C) and Timberwork (C) Operations (TS)" 14 Feb 1967.

~~TOP SECRET~~

C-b-100

Annex B to
Appendix C

C. (TS) BROWNFIELD REPORT, 1967-1968

The Brownfield Report was prepared by a group of officers from COMUSMACV Staff in late 1967 and early 1968, following closely on the heels of the report prepared by the CINCPAC Survey Group in November 1967. As a consequence, the Brownfield Report has integrated into its conclusions and recommendations, comments on the CINCPAC report, as appropriate. The portion of the report dealing with the agent team program is quoted below.

"1. (TS) Conclusions. It is concluded that:

"a. The long-term agents/agent team program has not been overly successful in terms of intelligence collection, harassment and interdiction of LOC, and assistance to downed aircrews.

"b. No success has been achieved in exfiltrating long-term agents/agent teams.

"c. The reliability of most intelligence produced by the long-term agents/agent teams is questionable.

"d. Agents recruited for TIMBERWORK(C) teams are of low caliber due to the highly competitive market for qualified agent candidates from out-of-country resources.

"e. The environment of the operations area has become more hostile as indicated by the increase in the number of internal security forces and anti-aircraft defense coverage.

"f. TIMBERWORK(C) teams have caused considerable political worry to the NVN Government.

"g. The success of STRATA teams to date to penetrate and survive in the area of operations indicates that MACSOG's plans to employ 20 teams in 1968 as being extremely ambitious.

"h. The current staffing level of OP-34 and the Strategic Technical Directorate is adequate to support the TIMBERWORK(C) program.

"j. More definite phased planning is required.

"2. (TS) CINCPAC Report

"a. CINCPAC Conclusions

"(1) The program should be reoriented.

"(2) The efforts of the TIMBERWORK(C) program should be directed toward:

"(a) Development of a NOTIONAL RESISTANCE organization in NVN (SSPL).

"(b) The establishment and maintenance of a low-level intelligence apparatus in NVN.

"b. Group comment on CINCPAC conclusions: concur.

"c. CINCPAC Recommendations

"Although it has been concluded that the TIMBERWORK(C) program has not been successful (based on the current mission directives with existing restrictions), the current organization and apparatus should be continued for the following reasons:

"(a) A complete phase-down would be evidence of a weakening on our side.

"(b) The in-place agents/agent teams cause considerable political worry to the North.

"(c) The present teams cause diversion of NVN military and security assets.

"(d) The US military should reserve (even on a stand-by basis) a capability with some experience in operations in denied areas against the time when policy may change.

"(e) The organizational nucleus, assets, facilities, and hardware to pursue or conduct UW in NVN are available and required for the suggested reorientation.

"d. Group comment on CINCPAC's recommendations: concur.

"e. CINCPAC Recommended Actions

"To implement a reoriented TIMBERWORK(C) program, the following actions are suggested:

"(a) Continue operations with existing teams to maximize intelligence collection possibilities and/or to support the NOTIONAL RESISTANCE organization.

"(b) Intensify and refine external recruitment both to improve operations and to spread indications to the NVN security of expanded operations (the latter will support the NOTIONAL RESISTANCE facade).

"(c) De-emphasize the infiltration of long-term Black teams, limiting operations to activation of low-level intelligence nets and secure base areas in tribal areas.

"(d) Develop a capability for short duration "gray singleton agent" operations in the high priority target areas 17°-20° North. Agents will be drawn from POW and Chieu Hoi channels to obtain relatively current area knowledge.

"f. Group comment on CINCPAC recommended actions: concur.

"3. (S) Group Recommendations. It is recommended that:

"a. The TIMBERWORK(C) program be reoriented to de-emphasize the employment of long-term agents/agent teams.

"b. The main effort of the TIMBERWORK(C) program be placed on intelligence collection and the development of a NOTIONAL RESISTANCE group in NVN.

"c. The TIMBERWORK(C) mission statement be changed to reflect the current activities of the program and to reorient the effort as recommended mission statement is: 'Infiltrate agents/agent teams into NORTH VIETNAM for the purpose of supporting psychological warfare operations and the conduct of intelligence

collection. Teams will perform such functions as target acquisition, development of intelligence nets, distribution of PSYOP material, and

"d. Every effort be made to exfiltrate selected long-term agents from NORTH VIETNAM for debriefing, program reorientation and possible re-insertion.

"e. Every effort be made to recruit potential agent candidates from RVN.

"f. A periodic review and analysis of the STRATA team program be undertaken by MACSOG to establish a realistic goal of the number of missions to be conducted.

"g. New methods and techniques of infiltrating agents into NORTH VIETNAM be studied."*

D. (S) SECURITY REVIEWS

Two detailed reviews of the security status of the long-term agent teams have been performed: the [redacted] review in 1967 and CAS/J-2 review one year later in 1968. The results of these two studies are outlined below.

1. (S) [redacted] Report. In a memorandum to Chief, SOG, the Special Assistant to SOG (CAS representative) summarized the results of [redacted] survey as follows:

"a. CAS has now completed its review of all active OP-34 teams. The results of our findings are summarized below for your convenience:

"(1) Probably Under Hostile Control. Teams ROMEO, HADLEY, TOURBILLON and ARES.

"(2) Doubtful Status. Team EAGLE.

"(3) Probably Not Under Hostile Control. Teams RUMUS, EASY ALPHA, VERSE.

"(4) Missing/Captured (not reviewed). Teams BELL and HECTOR.

"b. Individual reviews, with suggested actions possibly pertinent to each team, are appended to this Memorandum. With regard to the four teams regarded as probably uncontrolled, we understand the status of planning is as follows:

"(1) EASY ALPHA and EASY are being joined for greater defensive strength and to reduce the possibility of mutual contamination since they are operating in adjacent areas.

"(2) Team VERSE is to be exfiltrated at first opportunity, since their viability in the present area is considered poor.

"(3) Team REMUS is being considered for reinforcement with a wire-tap capability."**

* (S) Report, MAC J-3, "Ad Hoc Evaluation Group Report," 14 Feb 68, TIMBERWORK(C), pp 16-18 (SACSA).

** (S) Memorandum, Special Assistant to Chief, SOG, "Security Review of OP-34 Teams," 2 Jul 67.

1.5(c)
3.4(b)(1)

1.5(c)
3.4(b)(1)

2. (TS) ~~CAS/J-2~~ MACV Review. In May 1968, COMUSMACV confirmed* that the team described in an NVN news release announcing the capture of seven "spy commandoes" was Team REMUS. JCS replied that the developments with respect to REMUS raised a serious question as to the security of all agent teams. MACV was asked to conduct a security survey with the assistance of CAS Saigon.** The report of this survey, summarized below, not only concluded that all agent teams were compromised, but also that many basic errors in training and operating procedures had contributed to the poor record of agent team operations.

a. Conclusions of CAS/J-2 Report. In addition to the four teams reported under enemy control by the ~~██████~~ Report, EAGLE, EASY, and RED DRAGON were also concluded to be compromised.

1.5(e)
3.4(b)(1)

b. The Enemy. The report brought out that the Minister of Public Security (MPS), the opposition service in NVN, is a highly effective organization and has "handled" the controlled teams in a very professional manner. As a result, the evidence of compromise was not easy to come by and required much careful study of many details to determine general trends and impressions. Specific glaring, flagrant evidence of hostile control was not found. It was the opinion of the survey writers that "those operations which have been doubled by the opposition were done so to establish or maintain penetration agents in place within GVN and US agencies, particularly within STD."***

c. Criteria Used to Establish "Compromised" Teams. The one factor which was identified as the most reliable indicator of a team's compromise was its failure to respond to an order to exfiltrate. When the order to exfiltrate has been given, the normal response has been the termination of communications within 30 days. The other factors although less consistent also warrant close scrutiny: (1) significant lapses in team communications, and (2) reticence to perform assigned missions.

* (TS) Msg, MACV, DTG 140830Z May 68
 ** (S) Msg, JCS, DTG 142204Z May 68 (SACSA)
 *** (S) Report, CAS/J-2 USMACV, "Security Status of MACSOG Long-Team Agent Teams in NVN," 7 July 1968 (SACSA).

d. Problem Areas. The problem areas, briefly covered 1
below were considered to be the cause of the hostile com- 2
promise of the teams or the failure to detect the compromise 3
earlier. 4

(1) Lack of Personnel Compartmentation 5

"Throughout the operational cycle, there occurs extensive overlapping among the agent-recruits, commencing with recruitment in the same refugee areas of persons well known to each other who, subsequently, are assigned to separate missions in different target areas. ...Lack of compartmentation at training facilities also creates a security situation which can result in compromise. Team members have been trained together, held in staging areas together, and then are launched as separate teams into different target areas -- in at least one instance from the same aircraft."*

(2) Security of Counterpart Organization. Some 6
specific instances of poor security within STD were 7
pointed out in the report: (a) a member of STD's medical 8
staff is the father of two members of Team EASY, (b) a 9
senior STD operations officer is related to a team member, 10
(c) an STD guard is related to REMUS-8 and has been used 11
as a point of contact, and (d) an unidentified member of 12
STD is related to the leader of Team HECTOR. 13

(3) Multiple and Incompatible Team Missions. Assigned 14
team missions have frequently been incompatible with the 15
team's clandestine existence. The conduct of missions 16
such as sabotage, ambush, wire destruction has been inimical 17
to long-term security. 18

"The situation in North Vietnam, where the population is under tight security control and were a friendly population. base is lacking, makes long-term black agent-team operations self-defeating, regardless of mission type. To conduct missions which call attention to the presence of such teams only hastens their compromise."**

(4) Frequent Resupply Missions and Unlocated Resupply 19
Bundles. The shortage of good drop zones in NVN has 20
necessitated the repeated use of the same zone for a given 21
team. The result has been to simplify the local security 22
forces task of locating teams. 23

* (S) Ibid., p. 8.

** (S) Ibid., p. 9.

(5) Authentication of Team Security Following Insertion.

The lack of sophistication in radio authentication procedures and the reliance on STD communications personnel to judge on the safety or duress signal on incoming messages placed this entire system in serious doubt.

3. (TS) CINCPAC Comments. The purposals of MACV and CINCPAC in view of the security review-findings were outlined in an August message:

"a. Continuance of the TIMBERWORK(C) program.

"b. Continued support of selected in-place teams on a case-by-case basis giving full consideration to safety of forces.

"c. Exploitation of in-place teams to further the diversionary program.

"d. Maintenance and expansion of the diversionary program.

"e. Future insertion of new agent teams into NVN to enhance the credibility of the notional program."*

E. (S) CINCPAC STRATA TEAM EVALUATION

STRATA team operation were analyzed in September 1968, just prior to the bombing halt. The analysis message and the answer from COMUSMACV provide an insight into the successes and shortcomings of the STRATA program one year after its inception.

1. (S) CINCPAC Analysis

"a. As of 19 September, an analysis of the daily progress, after-action, and debriefing reports received on the STRATA operations conducted over the past year revealed the following:

"(1) The initial three STRATA teams were formed from then existing TIMBERWORK(C) assets. Two of these teams were later dropped as unreliable and one was MIA on its first mission.

* (S) Msg, CINCPAC, DTG 110430Z Aug 68 (SACSA)

"(2) Twenty-four (24) missions have been conducted.

"(3) Seventeen (17) means have been infiltrated/exfiltrated intact.

"(4) Three teams have been exfiltrated minus key personnel.

"(5) Teams infiltrated 27 Oct 67 and 14 May 68 are MIA.

"(6) Two teams are now in the OPAREA.

"(7) Only four teams (S-114, S-117, S-115 and S-119) appear to have completed primary mission of roadwatch and reported movements, truck parks and motor pool locations. However, there is no discernible evidence of tactical reactions to this reporting.

"(8) Of the four teams cited in (7) above, only S-117 was exfiltrated intact. S-114 was extracted minus the team leader, assistant team leader, and radio operator. S-115 reported three members MIA as a result of firefight. S-119 reported the team leader and a scout MIA on reconnaissance. Except for two complete teams reported as MIA, no non-productive missions have resulted in lost personnel.

"b. Based on the above findings, the following comments and suggestions are provided:

"(1) Infiltration/exfiltration techniques have proven to be sound.

"(2) Agent and team training has improved over the past year; however, a real-time reporting capability coupled with tactical reaction to reported targets could further enhance team effectiveness.

"(3) The recently completed MACV J-2/CAS security survey highlighted the known and suspected penetrations/compromises in the TIMBERWORK(C) program. The loss of key personnel on productive missions coupled with the fact that TIMBERWORK(C) resources provided personnel for STRATA teams suggests that a security survey be conducted on STRATA assets and facilities.

"(4) Since there is no available evidence that any team has reported a lucrative target which has been exploited tactically on a real-time basis, request CINCPAC be provided information on STRATA real-time reporting capability and STRATA-reported target reaction and tactical exploitation."*

2. (S) COMUSMACV Reply

"a. Reference suggests a security survey be conducted on STRATA and requests information on:

"(1) Real-time reporting capability.

"(2) Target reaction and tactical exploitation.

"b. An operational security inspection of MACSOG will be conducted by a CINCPAC OPSEC team on 11 Oct. STRATA assets and facilities are included in that inspection.

* (S) Msg, CINCPAC, DTG 210219Z Sep 68

"c. Reference paragraph a(1) through (6) your message, SOG conducted 22 STRATA insertions and 21 extractions into/from NVN during period 17 Mar-28 Sep 1968. One team (STRATA 120) is missing. Casualties were inflicted on teams 114, 115, 119, and 120. Fifteen (15) STRATA casualties (MIA) have resulted from a total insertion of 164 personnel this year. Fifty-seven (57) STRATA personnel are now in the operational status. Five enemy are known KIA by body count. On other occasions, mines emplaced by STRATA have been detonated with undetermined casualty producing effect.

"d. Reference paragraph a(7) your message, following discernible evidence of tactical reaction to STRATA reporting is submitted:

"(1) STRATA 114 reported on 12 Jun 68 a truck park and motor pool in addition to other convoy information. This target was attacked.

"(2) STRATA 119 reported on 5 Aug 68 a truck park and a by-pass trail. This by-pass information assisted targeting officers in deciding flow of enemy traffic and other probable truck parks.

"(3) STRATA 115 reported on 6 Aug 68 a well used trail. That report coupled with enemy ground fire directed towards FAC aircraft flying over that area resulted in air strikes along this infiltration route.

"(4) STRATA 118 upon extraction on 21 Aug 68 reported enemy troops. This target was attacked on 22 Aug in conjunction with a strike against known antiaircraft positions in same area.

"(5) STRATA 115 verified the existence of a four meter wide road which had been periodically bombed by 7th AF aircraft. The STRATA team determined that this road was no longer used. This information resulted in halting air strikes into an unproductive area.

"(6) STRATA 117 roadwatched Route 196. This route was found to be unused. Its status is reflected on the air target list.

"e. Reference paragraph b(1) your message, infiltration/exfiltration techniques are under constant review to improve performance and to avoid stereotyped operations.

"f. Reference paragraph b(2) your message, one method of improving real-time reporting capability and tactical reaction is being considered. That of using the U-10 for radio relay to increase time and area coverage for STRATA and other activities.

"g. Reference paragraph b(3) your message, four members of STRATA 115 were lost after being detected in their base camp by a dog and tracking party. They were the team leader, RTO and two members. This headquarters attributes the loss of other key personnel to the greater risks assumed by leaders. STRATA 114 lost its team leader, assistant and RTO at a road-watch site. STRATA 119 lost its team leader and a member while on reconnaissance to capture a prisoner.

"h. Reference paragraph b(4) your message, STRATA has following real-time reporting capability now in use:

"(1) PRC-74 for communication from team to FOB and to ABCCC. Link between team and FOB is reliable; link between team and ABCCC is unreliable. Causes are difficulty

in comprehension of brevity codes as spoken by indigenous personnel, rapid speech by ABCCC and matching of team antenna to ABCCC frequencies ACD orbit. Link between FOB and ABCCC is intermittent because of distances between stations.

"(2) PRC-25 for communications between team and FAC, at present: specially fraged FACs (O2-A) used for STRATA are available for insertion, extraction, direction finding and visual reconnaissance in STRATA target area. Stay time for O2-As flying from NKP is approximately two hours in STRATA target areas.

"i. The factors listed below limit the success of STRATA operations:

"(1) Operational techniques are still being developed and must be frequently adjusted to meet the enemy's response to STRATA infiltrations.

"(2) Majority of indigenous personnel have brief and limited military experience.

"(3) There is no pool of trained indigenous team leader personnel to draw upon.

"(4) Operational area is within North Vietnam.

"(5) Terrain is mountainous and covered by primary jungle.

"(6) Survival, mobility and observation are adversely affected by the north-east monsoon from November through April.

"j. Based on the facts cited above, we believe STRATA teams have done as well as could be expected. There is every reason to expect that as selection methods for STRATA personnel and training are improved the productivity of these teams will increase."*

* (S) Msg, COMUSMACV, DTG 010446Z Oct 68

~~SECRET~~
REDACTED CY

~~SECRET-NOFORN~~

PARKING AND RETIREMENT AREA

<u>NUMBER OF AIRCRAFT</u>	<u>REQUIRED AREA*</u>
4	111,375 Sq Ft
8	220,725 Sq Ft
12	332,100 Sq Ft
16	438,725 Sq Ft

* Optimum Parking Configuration

~~CI HAS NO OBJECTION TO
DECLASSIFICATION AND/OR
RELEASE OF THIS DOCUMENT
DATE NOV 24 1997 619849~~

~~SECRET-NOFORN~~

C-c- 198

Tab 18 to Annex C
to Appendix C

55-707 (5380)

Doc 7